

Operator's Manual



McELROY

www.mcelroy.com



No.2LC & PitBull® No.14
Fusion Machines

Manual: 433901 Revision: N 9/09
Original Language: English





Introduction



Thank You for purchasing this McElroy product

The No.2LC (Locking Cam) and PitBull No.14 model fusion machines are designed to butt fuse polyethylene pipe as well as tees, ells and other fittings.

If fusing other thermoplastic pipe materials, refer to the pipe manufacturer's fusion procedures or appropriate joining standard.

The No.2LC fuses 1/2" CTS to 2" IPS (20mm to 60mm).

The PitBull No.14 fuses 1" IPS through 4" DIPS (32mm through 122mm) A four-wheel cart is also available.

With reasonable care and maintenance, these machines will give years of satisfactory service.

Before operating this machine, please read this manual thoroughly, and keep a copy with the machine for future reference. This manual is to be considered part of your machine.



PH01848-7-25-00

TX01083-9-22-09

World Class Training

This manual is intended as a guide only and does not take the place of proper training by qualified instructors. The information in this manual is not all inclusive and can not encompass all possible situations that can be encountered during various operations.

McElroy Manufacturing, Inc., offers advanced training classes to enhance efficiency, productivity, safety and quality. Training is available at our facility or on-site at your location. Call (918) 836-8611 or visit our website for online solutions at www.mcelroy.com.

TX01850-7-25-00



PH00917-8-1-5-97



Warranty



LIMITED WARRANTY

McElroy Manufacturing, Inc. (McElroy) warrants all products manufactured, sold and repaired by it to be free from defects in materials and workmanship, its obligation under this warranty being limited to repairing or replacing at its factory and new products, within **3 years** after shipment, with the exception of purchased items (such as electronic devices, pumps, switches, etc.), in which case that manufacturer's warranty applies. Warranty applies when returned freight is prepaid and which, upon examination, shall disclose to have been defective. This warranty does not apply to any product or component which has been repaired or altered by anyone other than McElroy or has become damaged due to misuse, negligence or casualty, or has not been operated or maintained according to McElroy's printed instructions and warnings. This warranty is expressly in lieu of all other warranties expressed or implied. The remedies of the Buyer are the exclusive and sole remedies available and Buyer shall not be entitled to receive any incidental or consequential damages. Buyer waives the benefit of any rule that disclaimer of warranty shall be construed against McElroy and agrees that such disclaimers herein shall be construed liberally in favor of McElroy.

RETURN OF GOODS

Buyer agrees not to return goods for any reason except upon the written consent of McElroy obtained in advance of such return, which consent, if given, shall specify the terms and conditions and charges upon which any such return may be made. Materials returned to McElroy, for warranty work, repair, etc., **must have a Return Material Authorization (RMA) number**, and be so noted on the package at time of shipment. For assistance, inquiry shall be directed to:

McElroy Manufacturing, Inc.
 P.O. Box 580550
 833 North Fulton Street Tulsa, Oklahoma 74158-0550
 PHONE: (918) 836-8611, FAX: (918) 831-9285.
 EMAIL: fusion@McElroy.com

Note: Certain repairs, warranty work, and inquiries may be directed, at McElroy's discretion, to an authorized service center or distributor.

DISCLAIMER OF LIABILITY

McElroy accepts no responsibility of liability for fusion joints. Operation and maintenance of the product is the responsibility of others. We recommend qualified joining procedures be followed when using McElroy fusion equipment.

McElroy makes no other warranty of any kind whatever, express or implied; and all implied warranties of merchantability and fitness for a particular purpose which exceed the aforesaid obligation are hereby disclaimed by McElroy.

PRODUCT IMPROVEMENT

McElroy reserves the right to make any changes in or improvements on its products without incurring any liability or obligation to update or change previously sold machines and/or the accessories thereto.

INFORMATION DISCLOSED

No information of knowledge heretofore or hereafter disclosed to McElroy in the performance of or in connection with the terms hereof, shall be deemed to be confidential or proprietary, unless otherwise expressly agreed to in writing by McElroy and any such information or knowledge shall be free from restrictions, other than a claim for patent infringement, is part of the consideration hereof.

PROPRIETARY RIGHTS

All proprietary rights pertaining to the equipment or the components of the equipment to be delivered by McElroy hereunder, and all patent rights therein, arising prior to, or in the course of, or as a result of the design or fabrication of the said product, are exclusively the property of McElroy.

LAW APPLICABLE

All sales shall be governed by the Uniform Commercial Code of Oklahoma, U.S.A.

Register your product online to activate your warranty: www.McElroy.com/fusion

(Copy information listed on the machine nameplate here for your records).

Model No. _____

Serial No. _____

Date Received _____

Distributor _____



Table of Contents



Equipment Safety

| | |
|--|-----|
| Safety Alerts | 1-1 |
| Read and Understand | 1-1 |
| General Safety | 1-2 |
| Wear Safety Equipment | 1-2 |
| Heater is Not Explosion Proof | 1-2 |
| Electric Motors are Not Explosion Proof | 1-3 |
| Electrical Safety | 1-3 |
| Facer Blades are Sharp | 1-3 |
| Heater is Hot. | 1-4 |
| Fusion Procedures | 1-4 |
| Periodically Check Temperature. | 1-4 |
| Do Not Tow Fusion Machine at Speeds Greater than 5 MPH | 1-4 |
| Positioning Fusion Machine | 1-5 |
| Transporting 2LC and 2CU Units. | 1-5 |

Overview

| | |
|------------------------------------|-----|
| Theory of Heat Fusion | 2-1 |
| PitBull No.14 Cart | 2-2 |
| Reversible Jaws & Levers | 2-3 |
| Outrigger Pipe Supports | 2-3 |
| Electric Facer. | 2-4 |
| Manual Facer | 2-4 |
| Cam Lock | 2-4 |
| Heater | 2-5 |
| Insulated Heater Stand | 2-5 |

Operation

| | |
|---|-----|
| Read Before Operating | 3-1 |
| Prepare Heater | 3-1 |
| Install Clamping Inserts. | 3-2 |
| Loading Pipe into Machine | 3-2 |
| Inserting Facer. | 3-2 |
| Positioning Pipe in Machine | 3-3 |
| Facing the Pipe Manually | 3-3 |
| Electric Facer. | 3-3 |
| Check Alignment of Pipe | 3-4 |
| Check Heater Temperature | 3-4 |
| Inserting Heater | 3-5 |
| Heating the Pipe | 3-5 |
| Fusing the Pipe | 3-5 |
| Optional Use of Torque Wrench | 3-6 |
| Removing Pipe | 3-6 |

COPYRIGHT © 2009

McELROY MANUFACTURING, INC.

Tulsa, Oklahoma, USA

All rights reserved

All product names or trademarks are property of their respective owners. All information, illustrations and specifications in this manual are based on the latest information available at the time of publication. The right is reserved to make changes at any time without notice.



Table of Contents

Maintenance

- Preventative Maintenance 4-1
- Cleaning the Machine 4-1
- Clean and Lubricate Guide Rods 4-1
- Pivot Pins and Shafts 4-1
- Remove Dirt 4-2
- Clean and Lubricate Bearings 4-2
- Clean Eyebolt Threads 4-2
- Fasteners Must be Tight 4-2
- Installing Butt Fusion Heater Adapters 4-3
- Clean Heater Surfaces 4-3
- Adjusting Heater Temperature 4-3
- Heater Indicator Light 4-4
- Facer and Blades 4-4
- Facer Guides 4-4
- Removable Cam Locks 4-5

Maintenance Checklist

- Maintenance Checklist 5-1

Determine Fusion Force

- Determine Fusion Force 6-1

Specifications

- No.2LC, PitBull No.14 and PitBull No.14 Cart 7-1



Fusion Equipment Safety



Safety Alerts



This hazard alert sign appears in this manual. When you see this sign, carefully read what it says. YOUR SAFETY IS AT STAKE.

You will see the hazard alert sign with these words: DANGER, WARNING, and CAUTION.



Indicates an imminently hazardous situation which, if not avoided, will result in death or serious injury.



Indicates a potentially hazardous situation which, if not avoided, could result in death or serious injury.



Indicates a hazardous situation which, if not avoided, may result in minor or moderate injury.

In this manual you should look for two other words: **NOTICE** and **IMPORTANT**.

NOTICE: can keep you from doing something that might damage the machine or someone's property. It may also be used to alert against unsafe practices.

IMPORTANT: can help you do a better job or make your job easier in some way.

TX00030-12-1-92



WR00051-11-30-92

Read and Understand

Do not operate this equipment until you have carefully read, and understand the "Safety" and "Operation" sections of this manual, and all other equipment manuals that will be used with it.

Your safety and the safety of others depends upon care and judgment in the operation of this equipment.

Follow all applicable federal, state, local, and industry specific regulations.

McElroy Manufacturing, Inc. cannot anticipate every possible circumstance that might involve a potential hazard. The warnings in this manual and on the machine are therefore not all inclusive. You must satisfy yourself that a procedure, tool, work method, or operating technique is safe for you and others. You should also ensure that the machine will not be damaged or made unsafe by the method of operation or maintenance you choose.



TX00031-12-8-92

WR00052-12-1-92



Fusion Equipment Safety



General Safety

Safety is important. Report anything unusual that you notice during set up or operation.

LISTEN for thumps, bumps, rattles, squeals, air leaks, or unusual sounds.

SMELL odors like burning insulation, hot metal, burning rubber, hot oil, or natural gas.

FEEL any changes in the way the equipment operates.

SEE problems with wiring and cables, hydraulic connections, or other equipment.

REPORT anything you see, feel, smell, or hear that is different from what you expect, or that you think may be unsafe.



SAFE1ST122292

TX00114-4-22-93

Wear Safety Equipment

Wear a hard hat, safety shoes, safety glasses, and other applicable personal protective equipment.

Remove jewelry and rings, and do not wear loose-fitting clothing or long hair that could catch on controls or moving machinery.

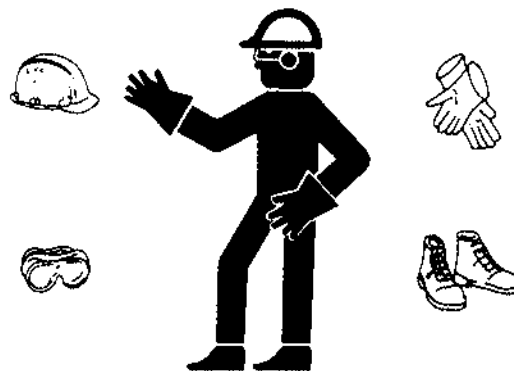

WR00053-12-2-92

TX00032-4-7-93

Heater Is Not Explosion Proof



This heater is not explosion proof. Operation of heater in a hazardous environment without necessary safety precautions will result in explosion and death.

If operating in a hazardous environment, the heater should be brought up to temperature in a safe environment, then **unplugged before entering** the hazardous atmosphere for fusion.



WR00034-11-30-92

TX00100-9-16-94



Fusion Equipment Safety



Electric Motors are Not Explosion Proof



Electric motors are not explosion proof. Operation of these components in a hazardous environment without necessary safety precautions will result in explosion and death.

The armature brushes must be removed from the electric motor when manually operating in a hazardous condition. Unscrew the brushes from both sides of the motor. (Both brushes must be removed). A 7/8" hex shaft allows for manual operation in hazardous conditions.

TX00873-9-22-09



WR00080-4-12-93

Electrical Safety



Always ensure power cords are properly grounded. It is important to remember that you are working in a wet environment with electrical devices. Proper ground connections help to minimize the chances of an electric shock.

Frequently inspect electrical cords and unit for damage. Have damaged components replaced and service performed by a qualified electrician.

Do not carry electrical devices by the cord.

NOTICE: Always connect units to the proper power source as listed on the unit, or in the owner's manual. On units with two power cords, plug each cord into separate power circuits. Do not plug into both outlets of one duplex receptacle.

NOTICE: Disconnect the machine from the power source before attempting any maintenance or adjustment.

TX00105-4-12-93



WR00055-4-7-93

WR00025-11-30-92

Facer Blades Are Sharp



Facer blades are sharp and can cut. Never attempt to remove shavings while the facer is running, or is in the facing position between the jaws. Use care when operating the facer, and when handling the unit.

NOTICE: Disconnect power from the facer, and remove the facer blades before attempting any maintenance or adjustment.

NOTICE: Never extend the blade beyond the inner or outer circumference of the facer.

TX02378-1-24-05

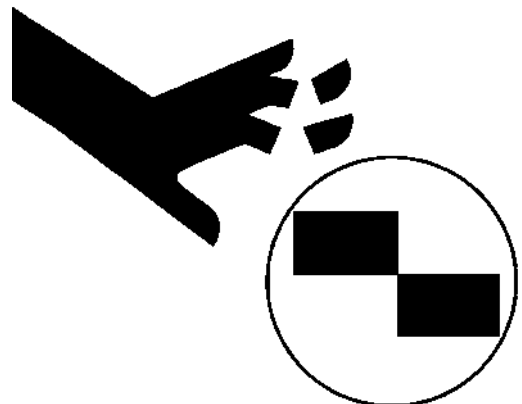

WR00073-4-6-93



Fusion Equipment Safety



Heater is Hot



The heater is hot and will burn clothing and skin. Keep the heater in its insulated heater stand or blanket when not in use, and use care when heating the pipe.

NOTICE: Use only a clean non-synthetic cloth such as a cotton cloth to clean the heater plates.

TX00104-8-12-94



WR00030-2-10-93

Fusion Procedures

Obtain a copy of the pipe manufacturer's procedures or appropriate joining standard for the pipe being fused. Follow the procedure carefully, and adhere to all specified parameters.



Failure to follow pipe manufacturer's procedure could result in a bad joint. Always follow pipe manufacturer's procedures.

TX02984-5-4-09

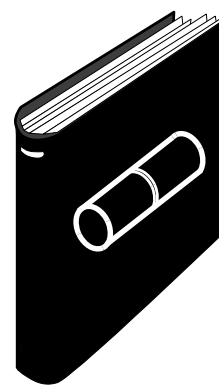

WR00079-1-24-96

Do Not Tow Fusion Machine at Speeds Greater than 5 MPH



The chassis is not designed for over-road towing. Towing at speeds greater than five miles per hour can result in machine damage as well as injury. Always transport the machine by flatbed truck or similar means, and make sure that unit is properly secured.

TX00101-4-12-93

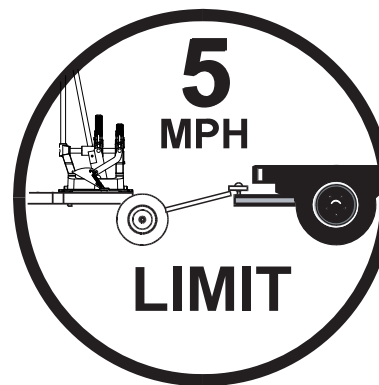

CD00632-7-25-00

Periodically Check Temperature

NOTICE: Incorrect heating temperature can result in bad fusion joints. Check heater plate surface temperature periodically with a properly calibrated pyrometer, and make necessary adjustments.

The thermometer on heaters indicates internal temperature, and should be used as a reference only.

TX00107-11-13-95

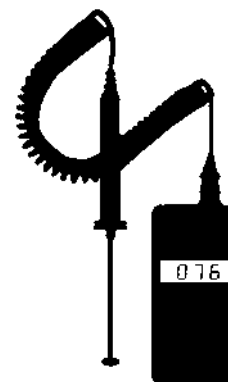

WR00077-4-16-93



Fusion Equipment Safety



Positioning Fusion Machine

Place fusion machine on as level ground as possible, and set the brake on the rear wheel. If it is necessary to operate machine on unlevel grade, chock the wheels and block the unit to make it as stable as possible.

TX00112-9-15-94

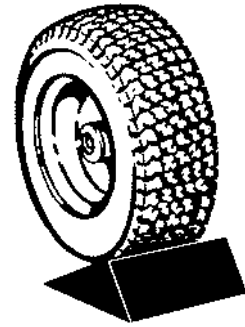

WR0007-6-4-7-93

Transporting 2LC and 2CU Units

On smaller machines it is easiest to carry the unit if the facer is securely installed and locked on the fusion unit. The facer has a handle that allows the unit to be firmly grasped and carried.

NOTICE: Do not carry unit by the lever handles because they can release or bend. Care must be used if the unit is grasped elsewhere because numerous pinch points exist.

TX00111-4-22-93

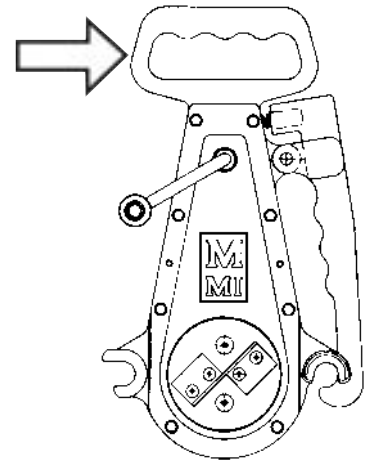

WR00081-4-22-93

Theory of Heat Fusion

The principle of heat fusion is to heat two surfaces to a designated temperature, and then fuse them together by application of force. This pressure causes flow of the melted materials, which causes mixing and thus fusion. When the polyethylene pipe is heated, the molecular structure is transformed from a crystalline state into an amorphous condition. When fusion pressure is applied, the molecules from each pipe end mix. As the joint cools, the molecules return to their crystalline form, the original interfaces are gone, and the two pipes have become one homogeneous pipe. The joint area becomes stronger than the pipe itself in both tensile and pressure conditions.

The principle operations include:

- Clamping** The pipe pieces held axially to allow all subsequent operations to take place.
- Facing** The pipe ends must be faced to establish clean, parallel mating surfaces perpendicular to the centerline of the pipes.
- Aligning** The pipe ends must be aligned with each other to minimize mismatch or high-low of the pipe walls.
- Heating** A melt pattern that penetrates into the pipe must be formed around both pipe ends.
- Joining** The melt patterns must be joined with a specified force. The force must be constant around the interface area.
- Holding** The molten joint must be held immobile with a specified force until adequately cooled.
- Inspecting** Visually examine the entire circumference of the joint for compliance with standards established by your company, customer, industry, federal, state, or local regulations.

Each pipe manufacturer has a slightly different approach for fulfilling the heating, joining, and holding phases, but the end result is the same – a fusion joint that is as strong or stronger than the pipe itself.

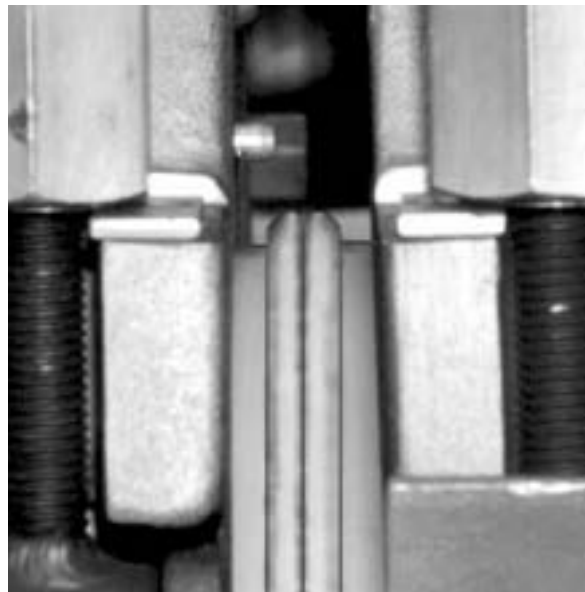

PH00363B-1-4-96



Overview



PitBull No.14 Cart

The PitBull No.14 fusion machine can be mounted on a No.14 four wheel cart for mobility and movement along the pipe line.

There is a clamping wheel lock on the left rear wheel to prevent rolling.

The cart is not designed for over-road towing.

⚠️WARNING Towing at speeds greater than 5 mph can result in machine damage as well as injury. Always transport the machine by flatbed truck or similar means.

The tongue on the tow bar has a ring to slip over a ball hitch so the machine can be conveniently maneuvered at the job site.

The cart has outrigger pipe supports that conveniently stow under the cart when not in use.

The PitBull No.14 Fusion Machine can be mounted on the cart in any one of three orientations. Older No.14 Fusion Machines can be mounted in one orientation. The machine is secured by two mounting posts and a sliding clamp block with an adjustable clamping lever.

To mount the fusion machine on the cart slide the mounting block toward the tow bar. Insert one edge of the fusion machine base under the mounting posts. Slide the clamp block up against the other edge and secure it with the adjustable clamping lever. To disengage and swivel the adjustable clamping lever handle pull up on it by pressing the button with a thumb.

Please note the mounting position for older style No.14 Fusion Machine. Use the two inboard mounting posts.

Please note mounting position for newer style PitBull No.14 Fusion Machine. Use the two outboard mounting posts.



PH01876-7-25-00



PH01891-7-25-00

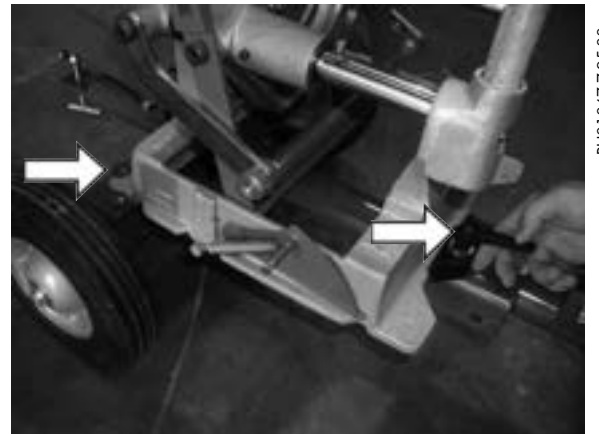

PH01867-7-25-00

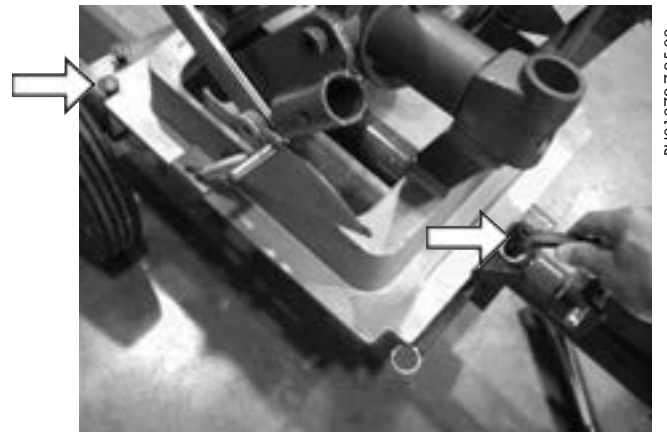

PH01872-7-25-00

TX01843-7-25-00



Overview



Reversible Jaws & Levers

The No. 14 PitBull upper jaws and control levers are reversible from one side to the other. This allow the machine to be operated from either side. The jaws and clamp knobs can be removed by using a pair of snap ring pliers to release the hinge pins.

The lever handles can be moved from one side to the other by depressing their spring pins and pulling them out. Put the lever in the desired socket and make sure its pin engages the hole. The levers should be on the side opposite the clamp knobs.

Notice: When the top jaws are reversed they should be switched between lower jaws so that the spring pins are both on the outboard sides away from the facer blades.

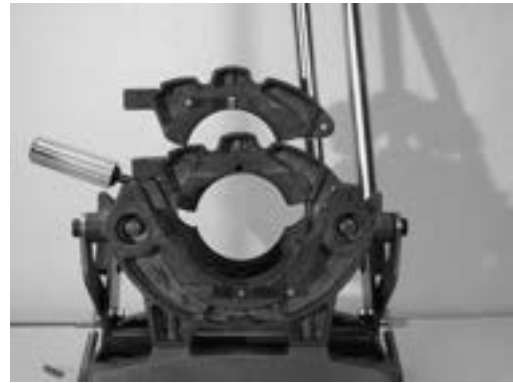

PH01881-7-25-00

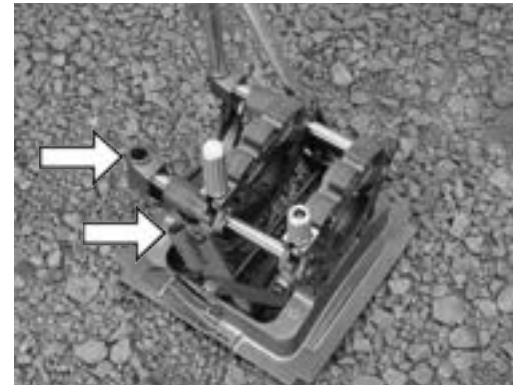

PH01880-7-25-00

TX02060-9-20-02

Outrigger Pipe Supports

The PitBull No.14 cart comes equipped with two outrigger pipe supports that can be used to help line up the pipe in the machine. When not in use they are fastened with pins under the cart.

To use the outriggers, simply remove attaching pins, pull outriggers out and reinstall on the top front and back of the cart with attaching pins.

The outriggers rest on adjusting screws that can be adjusted up or down for proper pipe alignment. A wing nut on each adjusting screw locks the screw setting in place.

TX01844-7-25-00



PH01890-7-25-00



PH01874-7-25-00



PH01873-7-25-00



Overview



Electric Facer

The facer is a McElroy Rotating Planer Block Design. The blade holders each contain two cutter blades. The block rotates on ball bearings and is chain driven (enclosed in lubricant) by a heavy duty electric motor. When operating in a hazardous environment, operate the facer manually.

⚠ DANGER Electric motors are not explosion proof. Operation of these components in a hazardous environment will result in explosion and death.

The armature brushes must be removed from the electric motor when manually operating in a hazardous condition. Unscrew the brushes from both sides of the motor. (Both brushes must be removed). A 7/8" hex shaft allows for manual operation in hazardous conditions.

The facer has a handle that latches into place on a guide bar. The handle must be pulled out to unlatch and remove facer.

The electric facer is symmetrical and can be inserted from either side.

The facer should be stored in the stand when not in use.

NOTICE: Never extend the blade beyond the inner or outer circumference of the facer.

TX02472-03-29-05



PH02330-4-29-02

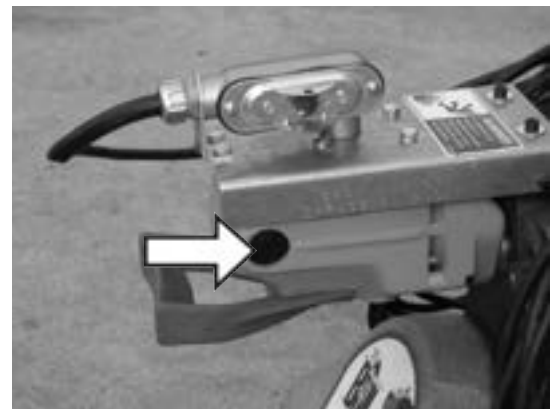

PH01847-7-25-00

Manual Facer

The manually operated facer has a hand powered crank. Turn the crank counterclockwise for facing.

TX00836-1-5-96



PH00657-1-4-96

Cam Lock

A semi-automatic cam locking system locks the movable jaw during the cooling cycle.

TX00837-1-5-96

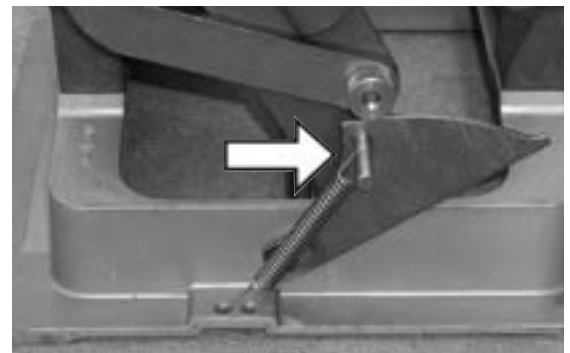

PH01846-7-25-00

Heater



Heater is not explosion proof. Operation of heater in a hazardous environment without necessary safety precautions will result in explosion and death.

If operating in a hazardous environment, heater should be brought up to temperature in a safe environment, then unplugged before entering the hazardous atmosphere for fusion.

The heater has a green indicator light which will flash on and off. This indicates that the controller is operating normally. If the green indicator is not flashing then the controller may not be operating properly. If this occurs, disconnect power and have the heater repaired by a McElroy Authorized Service Center.

The heater temperature is controlled by a microprocessor. It has a red indicator light on the handle at the bottom of the temperature scale. When the heater is plugged in and preheating the light glows steadily until the set temperature is reached. The light then goes off and on slowly as the heater maintains temperature.

The heater body is not coated. Coated butt fusion heater adapters are available for all butt fusion applications.

NOTICE: The heater should never be used without butt fusion heater adapters installed.

To prevent a build-up of plastic pipe residue from accumulating on the heater plates (loss of surface temperature and pipe sticking may result), the heater plates should be cleaned with a non-synthetic cloth before and after every fusion joint.

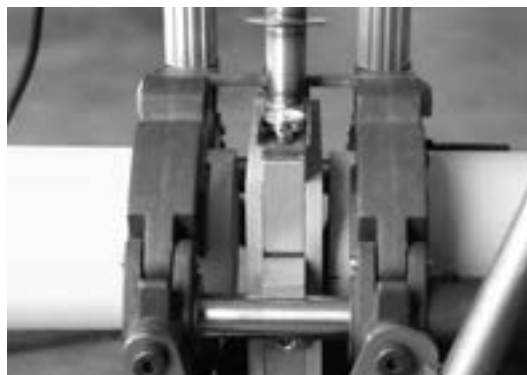

PH02331-4-29-02



PH02322-4-29-02

TX02216-09-18-03

Insulated Heater Stand

The heater should always be stored in the insulated heater stand or blanket for protection of the operator and to minimize heat loss and risk of mechanical damage.



PH02330-4-29-02

TX00363-9-15-94



Read before Operating

Before operating this machine, please read this manual thoroughly and keep a copy with the machine for future reference.

The fusion procedures in this manual are for use with the polyethylene pipe. If fusing other thermoplastic pipe materials, refer to the pipe manufacturer's suggested procedures or appropriate joining standard.

TX00838-9-28-09



PH01054-2-097

Prepare Heater



Heater Is Not Explosion Proof. Operation of heater in a hazardous environment without necessary safety precautions will result in explosion and death.

If operating in a hazardous environment, heater should be brought up to temperature in a safe environment, then unplugged before entering the hazardous atmosphere for fusion.

Install butt fusion heater adapters.

NOTICE: The heater should never be used without butt fusion heater adapters installed. Refer to the "Maintenance" section of this manual for installation procedure.

Place heater in insulated heater stand.

Plug heater into a proper power source.

Allow heater to warm-up to operating temperature.

Refer to the "Maintenance" section of this manual for instructions on how to adjust heater temperature.

TX00366-9-16-94



PH02330-4-29-02

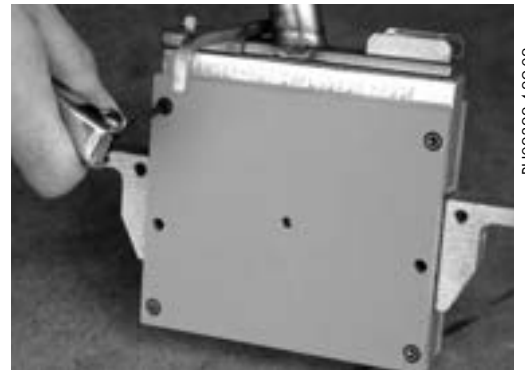

PH02322-4-29-02



Operation



Install Clamping Inserts

Select and install appropriate clamping inserts for the pipe that is being fused.

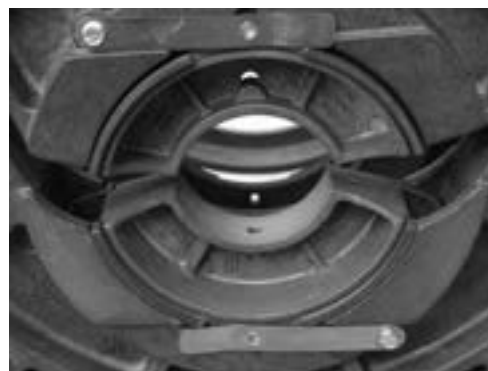

PH011856-7-25-00

For use with 4" DIPS pipe the 4" IPS masters inserts must be removed. Pull the spring pins out of their hole and rotate them outward putting the pin in the jaw pockets. Loosen the insert attachment screw with the furnished 5/32" hex screwdriver then rotate the insert in the jaw so the keyhole lines up with the screw head and pull out the insert.



PH01883-7-25-00

X01846-7-25-00

Loading Pipe Into Machine

Clean the inside and outside of pipe ends that are to be fused. Open the upper jaws and insert pipe in each pair of jaws with applicable inserts installed. Let the ends of the pipe protrude about 1" past the face of the jaws. Close upper jaws but do not clamp tight.



PH01871-7-25-00

TX01847-7-25-00

Inserting Facer

Place the end opposite the handle onto the far guide rod, then lower the facer handle end down onto the near guide rod and latch.



PH01888-7-25-00

TX01851-7-25-00



Operation



Positioning Pipe in Machine

Position the facer on the guide rods and lock into position. Using lever handle, bring pipe ends together against the facer, watching the gap between the facer stops and the pipe clamping jaws. Leave enough **gap** so that proper face-off will be achieved when the facer stops are bottomed out against the clamps. Tighten the pipe clamp knobs by hand until firm resistance is felt. Do not over-tighten.

NOTICE: Thoroughly clean all dirt and debris from pipe ends before facing.

TX00839-1-5-96

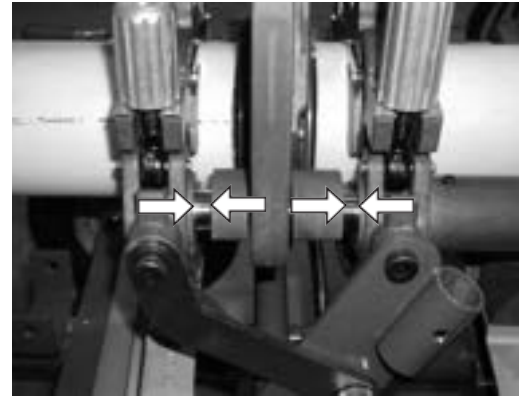

PH01870-7-25-00

Facing the Pipe Manually

Turn facer handle counterclockwise and apply firm pressure on lever handle. Continue facing until facer stops have bottomed out against the clamping jaws. Stop rotation of facer. Move jaws apart.

Unlatch and remove facer. Remove shavings from pipe ends and machine. Do not touch faced pipe ends.

Inspect both pipe ends for complete face off. If the face off is incomplete, return to **Loading Pipe Into Machine**.

TX01848-7-25-00

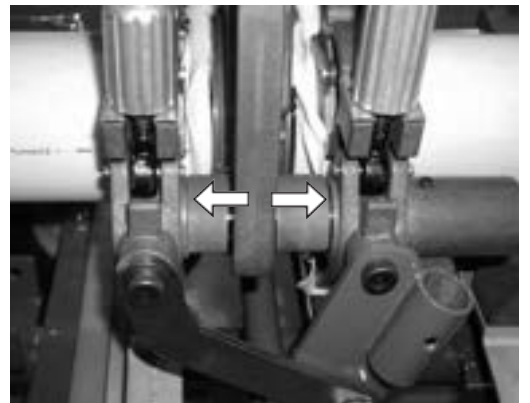

PH001869-7-25-00

Electric Facer

The electric facer should be started before the pipe is pushed into contact with the blades. Continue facing until the facer stops are against the jaws then turn off the facer while continuing to hold pressure closed on the lever until the facer stops completely.

Reverse force to the lever handle to move the pipe ends away from the facer. Unlatch and remove the facer taking care not to touch the pipe ends. Remove shavings from pipe ends and machine. Do not touch faced pipe ends as this may contaminate them.

If after facing any imperfections are visible on the ends of the pipe move the pipe inward and reface.

Any time clamp knobs are tightened pipe ends should be refaced.

TX01851-7-25-00



PH01886-7-25-00

Check Alignment of Pipe

Bring the pipe ends together under sufficient force to overcome any pipe drag or friction in the system. Check for alignment and proper face off. If high/low (misalignment) exists, adjust by tightening the clamp on the high side and reface the pipe.

NOTICE: When clamping, do not over-tighten the clamp knobs because machine damage can result. Check to see if there is space between the upper and lower jaws. If the two jaws are touching, do not continue to tighten. Bring the pipe ends together under fusion pressure plus drag to check for slippage. If slippage occurs, return to **Loading Pipe into Machine**.

TX02477-3-30-05

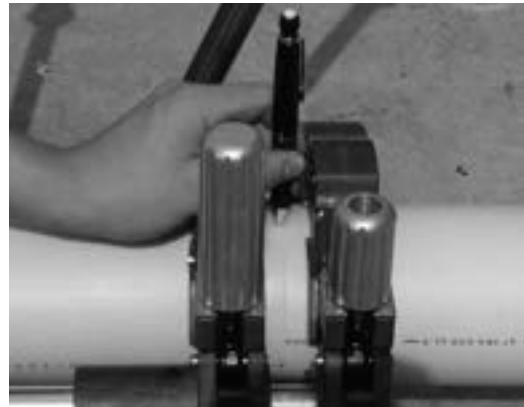

PH01848-7-25-00

Check Heater Temperature

CAUTION Incorrect heating temperature can result in questionable fusion joints. Check heater plates periodically with a pyrometer and make necessary adjustments.

Check heater surface temperature.

Refer to the pipe manufacturer's recommendations for proper heater temperature.

IMPORTANT: The dial thermometer on the heater indicates internal temperature which varies from the actual surface temperature.

The dial thermometer can be used as reference once the surface temperature has been verified.

TX00375-1-1-94

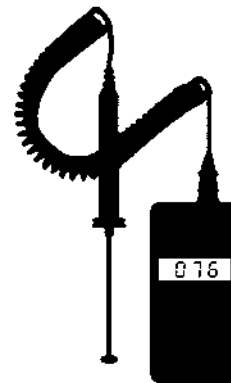

WR00077-4-16-93



PH02325-4-29-02



Operation



Inserting Heater



Heater Is Not Explosion Proof. This unit is not explosion proof. Operation of heater in a hazardous environment without necessary safety precautions will result in explosion and death.

If operating in a hazardous environment, heater should be brought up to temperature in a safe environment, then unplugged before entering the hazardous atmosphere for fusion.

Use a clean non-synthetic cloth to clean the butt fusion heater adapter surfaces.

Verify heater temperature by noting the reading on the dial thermometer.

Insert heater between the pipe ends. The stripper bar downward legs should be outside of the jaws. (not on top)

TX00377-9-15-94

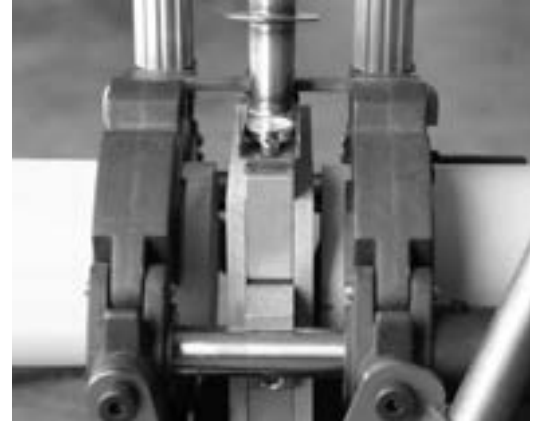

PH02331-4-29-02

Heating the Pipe

With heater in position between the pipe ends, snap pipe ends sharply against the heater to ensure alignment. Follow the pipe manufacturer's recommendations for heating time and pressure. Raise the locking cam into the engaged position while in the heating cycle.

TX00842-1-8-96

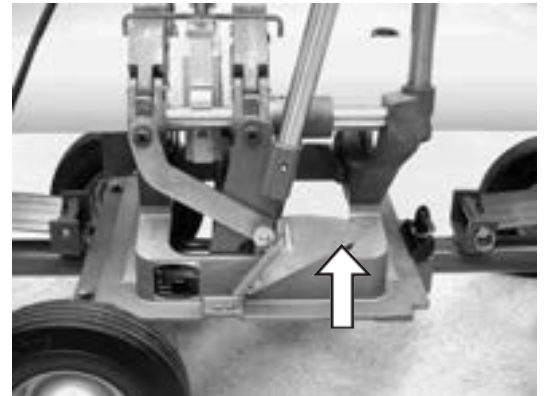

PH01892-7-25-00

Fusing the Pipe

After the heating cycle is completed, remove the heater and quickly apply fusion force with the lever handle in accordance with the pipe manufacturer's recommended fusion procedure or appropriate joining standard. A torque wrench can be used when a specified Interfacial Pressure is required. Hold this force for at least 10 seconds.

After 10 seconds, the locking cams will assist by holding force during the cooling cycle.



Failure to follow pipe manufacturer's heating time, pressure and cooling time may result in a bad joint.

TX02478-9-22-09



PH02327-4-29-02



Optional Use of Torque Wrench

When a specified Interfacial Pressure is required in the fusion procedure, a torque wrench can be used.

IMPORTANT: Use a torque wrench with the No. 14 PitBull place an adapter in the lever socket (Part # 410802). A 1/2" drive 100 ft-lb 15.0" torque wrench is required when using the torque wrench adapter. Using a torque wrench of a different length will result in different forces from the torque reading.

To calculate the proper torque reading see Section "Determine Fusion Force."

Add the torque required to overcome Drag (the force required to move the pipe at or near the point of fusion) to the torque reading to assure the proper joining force. This should be determined prior to inserting the heater.

CAUTION Failure to follow pipe manufacturer's heating time, pressure and cooling time may result in a bad joint.



PH01885-7-25-00



PH01866-7-25-00

TX02479-9-22-09

Removing Pipe

After pipe has cooled sufficiently, apply closing force on the lever handle and push the locking cams down into the unlocked position. Unscrew the clamp knobs enough that they can be swiveled outward.

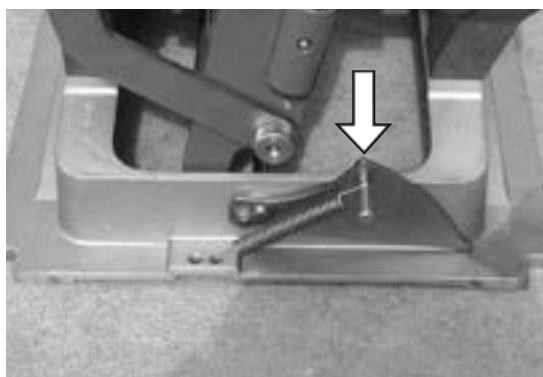

PH01863-7-25-00

TX00844-1-8-96



Maintenance



Preventative Maintenance

To insure optimum performance, the machine must be kept clean and well maintained.

With reasonable care, this machine will give years of service. Therefore, it is important that a regular schedule of preventive maintenance be kept.

Store machine inside, out of the weather, whenever possible.

TX00428-8-10-95

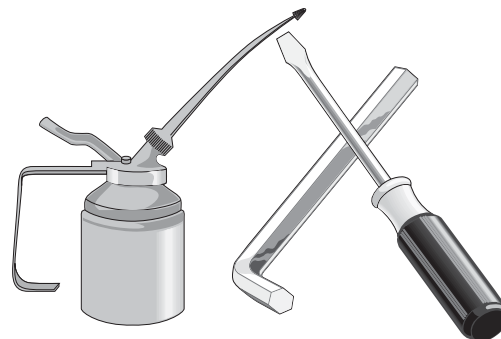

CD00142-11-2-94

Cleaning the Machine

Clean the machine with a soap and water wash as needed. Remove the heater and facer from the spray area before cleaning.

TX00862-1-30-96



CD00178-5-3-96

Clean and Lubricate Guide Rods

Remove oily dirt buildup from guide rods using WD-40® or similar solvent and wipe guide rods clean. Do not leave the cleaning agent on the guide rods.

Remove the 1/16" pipe plugs on each side of the moveable jaw. Lubricate guide rod bushings with SAE 10W-40 motor oil through the oil holes on the movable jaw. Replace the pipe plugs.

TX00863-1-30-96

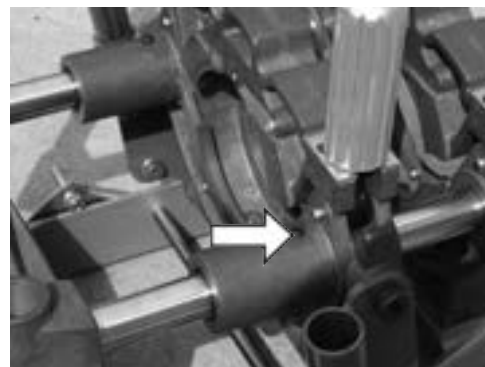

PH01865-7-25-00

Pivot Pins and Shafts

Occasionally add a drop of oil to pivot pins and shafts.

TX00864-1-30-96

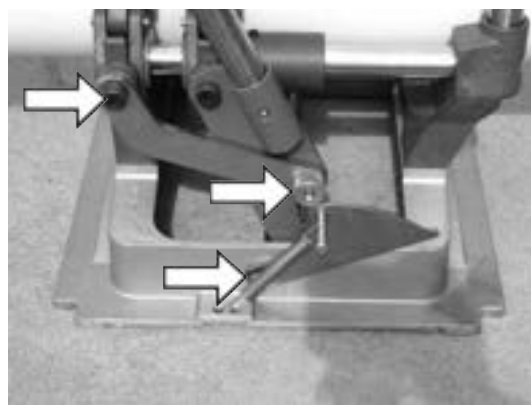

PH01864-7-25-00



Maintenance



Remove Dirt

Remove dirt from jaw and insert serrations and clamp knob eyebolts.

TX00865-1-30-96



PH018587-25-00

Clean and Lubricate Bearings

All clamp knobs are equipped with thrust bearings to reduce friction and improve efficiency of the clamping screw. Keep these bearings clean by washing in kerosene or solvent. They should be lubricated with light machine oil. These bearings must be replaced if they become inoperative.

TX00866-1-30-96



PH018597-25-00

Clean Eyebolt Threads

Keep the clamp knob eyebolt threads brushed clean with a soft bristle brush. The threads are coated with a black dry lubricant and do not require oiling.

TX01849-7-25-00



PH001859-7-25-00

Fasteners Must Be Tight

Check all nuts, bolts, and snap rings to make certain they are secure and in place.

TX00437-9-13-94



PH01846-7-25-00



Installing Butt Fusion Heater Adapters

The heater body of this assembly is not coated. Coated butt fusion heater plates are available for all butt fusion applications.

Butt fusion heater adapters are installed with eight Stainless Steel Cap Screws.

Care should be taken to assure that the butt fusion heater adapters are seated on the heater body, and that there is no foreign matter trapped between these surfaces.

IMPORTANT: Do not over tighten the screws.

The surface of the butt fusion heater adapters are coated with an antistick coating.

TX00443-9-22-94

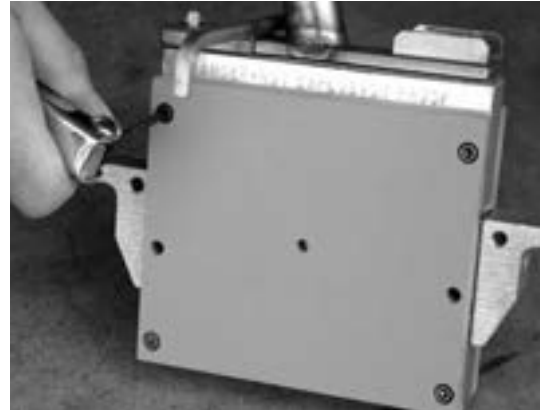

PH02323-4-29-02

Clean Heater Surfaces

The heater faces must be kept clean and free of any plastic build up or contamination.

Before each fusion joint the heater surfaces must be wiped with a clean, non-synthetic cloth.

NOTICE: Do not use an abrasive pad or steel wool. Use a non-synthetic cloth that won't damage surfaces.

TX00440-8-14-08



PH02322-4-29-02

Adjusting Heater Temperature

Turn knob to desired temperature. Measure the heater surface temperature with a pyrometer. Any variance must be corrected to the pyrometer reading.

Loosen setscrew in the knob. Turn knob to point to the same temperature as the pyrometer. Tighten setscrew in the knob.

Turn knob to desired temperature. Allow heater to stabilize at the new temperature (5 to 10 minutes) after adjusting.

The thermometer on the heater body indicates internal temperature and should be used as a reference only.



PH02314-4-29-02

TX02009-3-13-02



Maintenance



Heater Indicator Light

The heater has a green indicator light which will flash on and off. This indicates that the controller is operating normally. If the green indicator is not flashing then the controller may not be operating properly. If this occurs, disconnect power and have the heater repaired by a McElroy Authorized Service Center.

The heater has a red indicator light on the handle at the bottom of the temperature scale. When the heater is plugged in and preheating the light glows steadily until the set temperature is reached. The light then goes off and on slowly as the heater maintains temperature.

If the heater is not operating properly, the control will attempt to turn the heater off and the indicator light will flash rapidly. If this occurs, disconnect the power and take it to a McElroy Authorized Service Center for repair.

TX02213-09-16-03

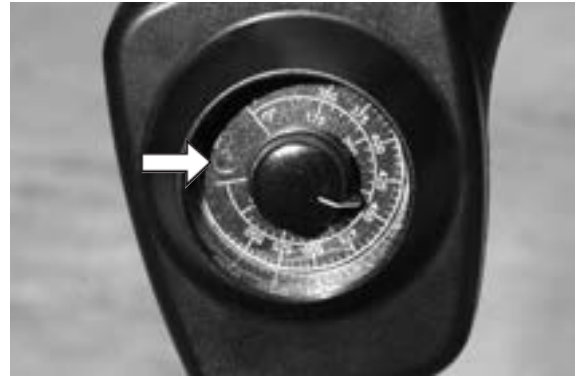

PH023144-29-02

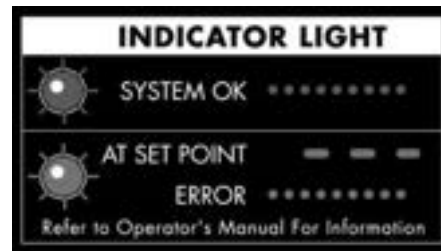

PH02571-11-05-03

Facer and Blades

The facers are packed with a high temperature grease at assembly. The facer does not require repacking of grease.

Inspect the facer blades for damage and sharpness. If dullness or damage appears on one section of the blade, installing the blade on the opposite side of the blade holder will normally position a sharp edge in the facing zone. Chipped or dull blades must be replaced.

NOTICE: Never extend the blade beyond the inner or outer circumference of the facer.

TX02473-3-29-05

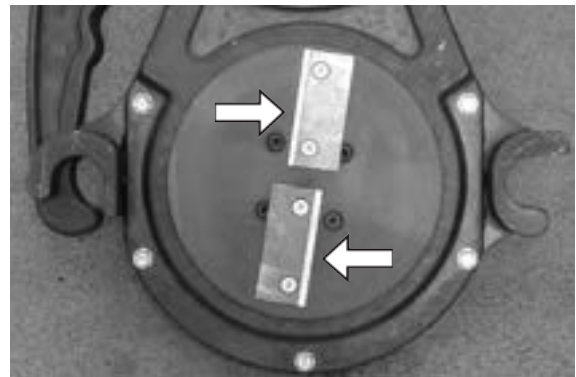

PH018607-25-00

Facer Guides

To minimize friction on the guide rods, keep the guides clean using a clean dry cloth to wipe away debris.

TX02480-3-30-05

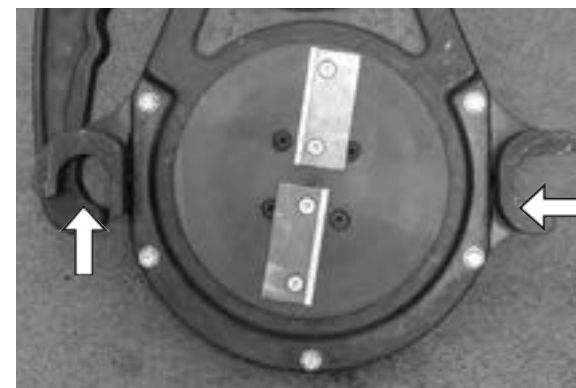

PH018607-25-00



Maintenance



Removable Cam Locks

Should the cam locks become worn or damaged they can be replaced. The cams are attached to the shaft by a keyhole joint and are held by springs.

TX02728-6-5-07



PH01882-7-5-00



Maintenance Checklist



No.2LC and PitBull No.14 Fusion Machine Checklist

| Item to Check | Satisfactory | Needs Repair | Repair Comments |
|---|--------------|--------------|-----------------|
| UNIT | | | |
| Machine is clean | | | |
| Clamp knob bearings lubricated and move freely | | | |
| Movable jaw lubricated and moves freely | | | |
| Locking cam works properly | | | |
| Guide rods are not damaged | | | |
| Clamping jaw and insert grooves are clean | | | |
| Spring clips work properly | | | |
| All nuts and bolts are tight | | | |
| Lever handles are with unit | | | |
| CHASSIS | | | |
| Brake and unit lockdown clamps are adjusted properly | | | |
| Outrigger adjusting screws work freely | | | |
| All nuts and bolts are tight | | | |
| FACER | | | |
| Check cord, plug and switch | | | |
| Check for play in blade holder | | | |
| Facer does not wobble when trapped between jaws | | | |
| Blades are in good condition | | | |
| Latch handle locks onto guide rod freely | | | |
| Facer moves on guide rods without excessive force | | | |
| Facer is clean and free of grease on blade holder surface | | | |
| HEATER | | | |
| Cord and plug are in good condition | | | |
| Heater surface is clean and in good condition | | | |
| Thermometer is in good working order | | | |
| Surface temperature checked with pyrometer | | | |

TX00875-2-9-96



Determining Fusion Force



Variable Definitions

- O.D. = Outside Diameter
- t = Wall Thickness
- Π = 3.1416
- SDR = Standard Dimensional Ratio
- IFP = Manufacturer's Recommended Interfacial Pressure

Formulas

$$t = \frac{\text{O.D.}}{\text{SDR}}$$

$$\text{AREA} = (\text{O.D.} - t) \times t \times \Pi$$

$$\text{FORCE} = \text{AREA} \times \text{IFP}$$

$$\text{REQUIRED FORCE} = (\text{O.D.} - t) \times t \times \Pi \times \text{IFP} + \text{DRAG}$$

Example

Pipe Size = 4" SDR 11

O.D. of Pipe = 4.5"

SDR of Pipe = 11

Recommended Interfacial Pressure = 75 PSI

Using a Model PitBull No.14 Fusion Unit

$$t = \frac{\text{O.D.}}{\text{SDR}} = \frac{4.5}{11} = 0.409$$

$$\text{REQUIRED FORCE} = (\text{O.D.} - t) \times t \times \Pi \times \text{IFP} + \text{DRAG}$$

$$\text{REQUIRED FORCE} = (4.5 - .409) \times .409 \times 3.1416 \times 75 + \text{DRAG} = 394 + \text{DRAG}$$

From Table:

30 ft/lbs of Torque = 330 lbs Force

and

40 ft/lbs of Torque = 435 lbs Force

Interpolating between these two values give approximately 36 ft/ lbs Torque.

$$\text{FUSION FORCE} = 36 \text{ ft/lbs} + \text{Drag (measured in ft/lbs)}$$

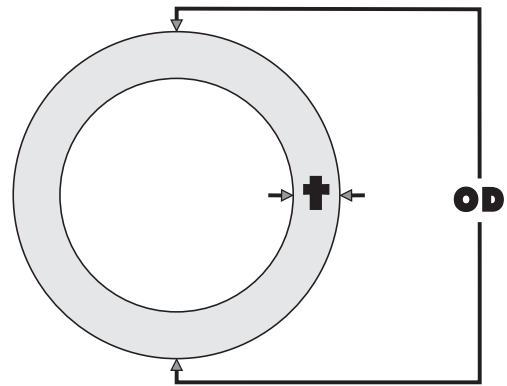

PH018857-25.00

This table is only valid when using a torque wrench and adapter used as shown in the picture above. A 1/2" drive 100 ft-lb 15.0" torque wrench with the torque wrench adapter. Using a torque wrench of a different length will result in different forces from the torque reading.

| Torque Wrench Reading (Ft Lb) | No.2LC Jaw Axial Force (Lb) | PitBull No.14 Jaw Axial Force (Lb) |
|-------------------------------|-----------------------------|------------------------------------|
| 10 | 70 | 115 |
| 20 | 135 | 215 |
| 30 | 200 | 330 |
| 40 | 260 | 435 |
| 50 | 320 | 545 |
| 60 | 400 | 660 |
| 70 | 480 | 780 |
| 80 | 550 | 915 |
| 90 | 635 | 1025 |
| 100 | 690 | 1140 |

TX02482-9-22-09-



Specifications

Model No.2LC

Specification:

Designed for 1/2" CTS to 2" IPS pipe
(20mm to 60mm)

Dimensions:

Width: 14" (357mm)
Length: 13" (330mm)
Height: 15" (381mm)

Weight: 23 lbs. (10.4Kg)

Heater: 800 W, 120 VAC, 60 Hz
(220 V, 50 Hz)

Model PitBull No.14

Specifications:

Designed for 1" IPS to 4" DIPS pipe
(32mm to 122mm)

Dimensions:

Width: 16.8" (425mm)
Length: 15.4" (391mm)
Height: 15.5" (394mm)

Weight: 37 lbs. (16.8Kg)

Heater: 1200 W, 120 VAC, 60 Hz
(220 V, 50 Hz)

Facer: 7 Amps @ 120 VAC (Running)
22 Amps @ 120 VAC (Stall)

PitBull No.14 Cart

Dimensions:

Width: 23" (584mm)
Length: 45" (1143mm)
Height: 15" (381mm)

Weight: 76 lbs. (34.4Kg)



Optional Accessories



Manual Fusion Machine Stand

The Manual Fusion Machine Stand makes working with the No.14 and No.2LC much easier. This stand expands to a comfortable operator level. The height corresponds to the McElroy pipe stands, PolyPorter™ and PolyHorse™ for easy pipe loading into the machine. When you are finished, it folds for easy storage and has wheels for transporting your machine to the next site.

Features:

- Designed for use with the No.14 & No.2LC fusion machines
- Compatible with McElroy pipe stands, PolyHorse & PolyPorter
- Locks in both folded and open positions
- More comfortable working height
- Wheels for easy transportation
- Folds for easy storage



PH03627-6-8-08



PH03628-6-8-08

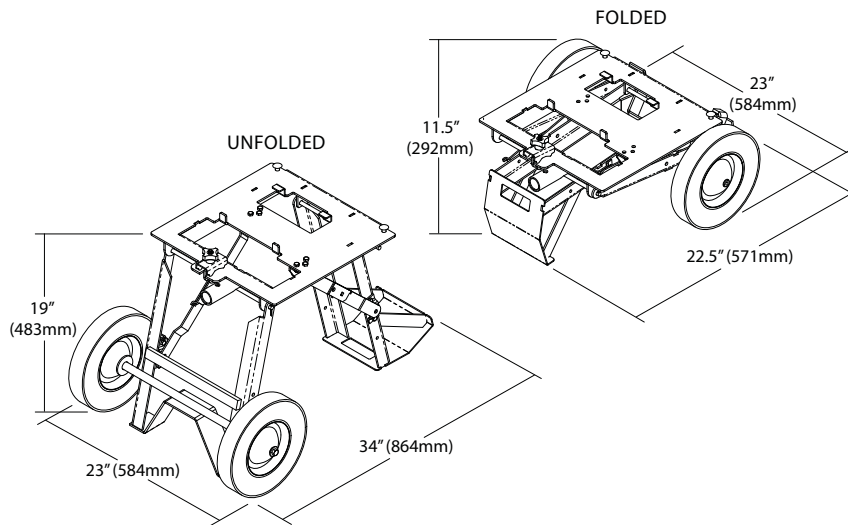

For more information, contact your distributor or visit www.mcelroy.com.

TX02809-7-8-08

CD00768-7-8-08

About this manual . . .

McElroy Manufacturing continually strives to give customers the best quality products available. This manual is printed with materials made for durable applications and harsh environments.

This manual is waterproof, tear resistant, grease resistant, abrasion resistant and the bonding quality of the printing ensures a readable, durable product.

The material does not contain any cellulose based materials and does not contribute to the harvesting of our forests, or ozone-depleting constituents. This manual can be safely disposed of in a landfill and will not leach into ground water.

TX001660-8-19-99



The leader by design.

P.O. Box 580550 Tulsa, Oklahoma 74158-0550, USA

www.mcelroy.com