

Operator's Manual



McELROY

www.mcelroy.com



No.412 & No.618 Fusion Machines

Original Language: English

Manual: 1869401 Revision: E 09/08

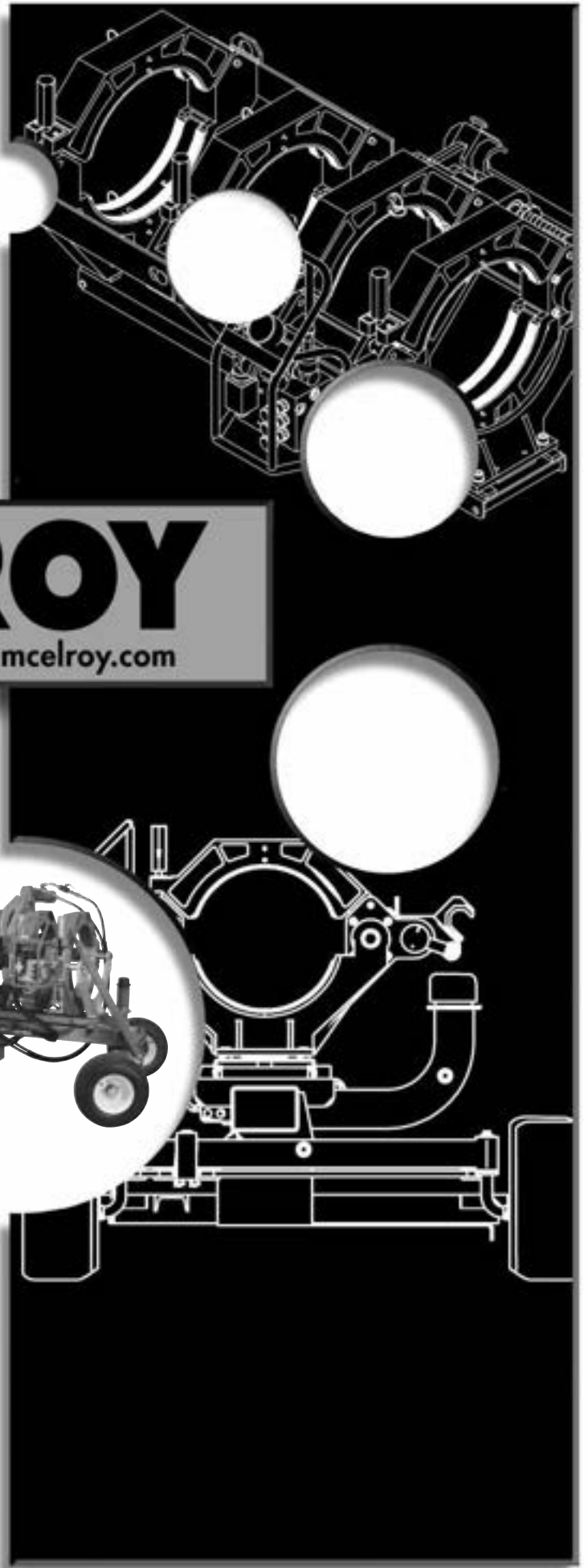

**California
Proposition 65 Warning**

*Engine exhaust from this product
contains chemicals known to the State
of California to cause cancer, birth
defects, or other reproductive harm.*



Introduction



Thank you for purchasing this McElroy product.

The No.412 and No.618 model fusion machines are self-contained and designed to produce consistently high quality polyolefin pipe butt fusion joints with a minimum of operator effort.

The No. 412 model fuses 4"IPS (4.50" OD) minimum, to 12 "DIPS (13.2" OD) maximum pipe.

The No.618 model fuses 6" IPS (6-5/8" OD) minimum to 18" IPS (18" OD) maximum pipe.

With reasonable care and maintenance, these machines will give years of satisfactory service.

TX01186-2-19-97

Before operating this machine, please read this manual thoroughly, and keep a copy with the machine for future reference. This manual is to be considered part of your machine. Always return the manual to the literature compartment.



PH02223-8-23-01

World Class Training

This manual is intended as a guide only and does not take the place of proper training by qualified instructors. The information in this manual is not all inclusive and can not encompass all possible situations that can be encountered during various operations.

McElroy Manufacturing, Inc., offers advanced training classes to enhance efficiency, productivity, safety and quality. Training is available at our facility or on-site at your location. Call (918) 836-8611

TX01083-12-10-96



PH00917-5-16-98



Warranty



LIMITED WARRANTY

McElroy Manufacturing, Inc. (McElroy) warrants all products manufactured, sold and repaired by it to be free from defects in materials and workmanship, its obligation under this warranty being limited to repairing or replacing at its factory and new products, within **3 years** after shipment, with the exception of purchased items (such as electronic devices, pumps, switches, etc.), in which case that manufacturer's warranty applies. Warranty applies when returned freight is prepaid and which, upon examination, shall disclose to have been defective. This warranty does not apply to any product or component which has been repaired or altered by anyone other than McElroy or has become damaged due to misuse, negligence or casualty, or has not been operated or maintained according to McElroy's printed instructions and warnings. This warranty is expressly in lieu of all other warranties expressed or implied. The remedies of the Buyer are the exclusive and sole remedies available and Buyer shall not be entitled to receive any incidental or consequential damages. Buyer waives the benefit of any rule that disclaimer of warranty shall be construed against McElroy and agrees that such disclaimers herein shall be construed liberally in favor of McElroy.

RETURN OF GOODS

Buyer agrees not to return goods for any reason except upon the written consent of McElroy obtained in advance of such return, which consent, if given, shall specify the terms and conditions and charges upon which any such return may be made. Materials returned to McElroy, for warranty work, repair, etc., **must have a Return Material Authorization (RMA) number**, and be so noted on the package at time of shipment. For assistance, inquiry shall be directed to:

McElroy Manufacturing, Inc.
 P.O. Box 580550
 833 North Fulton Street Tulsa, Oklahoma 74158-0550
 PHONE: (918) 836-8611, FAX: (918) 831-9285.
 EMAIL: fusion@McElroy.com

Note: Certain repairs, warranty work, and inquiries may be directed, at McElroy's discretion, to an authorized service center or distributor.

DISCLAIMER OF LIABILITY

McElroy accepts no responsibility of liability for fusion joints. Operation and maintenance of the product is the responsibility of others. We recommend qualified joining procedures be followed when using McElroy fusion equipment.

McElroy makes no other warranty of any kind whatever, express or implied; and all implied warranties of merchantability and fitness for a particular purpose which exceed the aforesaid obligation are hereby disclaimed by McElroy.

PRODUCT IMPROVEMENT

McElroy reserves the right to make any changes in or improvements on its products without incurring any liability or obligation to update or change previously sold machines and/or the accessories thereto.

INFORMATION DISCLOSED

No information of knowledge heretofore or hereafter disclosed to McElroy in the performance of or in connection with the terms hereof, shall be deemed to be confidential or proprietary, unless otherwise expressly agreed to in writing by McElroy and any such information or knowledge shall be free from restrictions, other than a claim for patent infringement, is part of the consideration hereof.

PROPRIETARY RIGHTS

All proprietary rights pertaining to the equipment or the components of the equipment to be delivered by McElroy hereunder, and all patent rights therein, arising prior to, or in the course of, or as a result of the design or fabrication of the said product, are exclusively the property of McElroy.

LAW APPLICABLE

All sales shall be governed by the Uniform Commercial Code of Oklahoma, U.S.A.

**Register your product online to activate your warranty:
www.McElroy.com/fusion**

(Copy information listed on the machine nameplate here for your records).

Model No. _____

Serial No. _____

Date Received _____

Distributor _____



Table of Contents



Equipment Safety

Safety Alerts	1-1
Read and Understand	1-1
General Safety	1-2
Wear Safety Equipment	1-2
Fuel Handling	1-2
Units with Engines	1-3
Carbon Monoxide	1-3
Heater is Not Explosion Proof	1-3
Electric Motors are Not Explosion Proof	1-3
Battery	1-4
Electrical Safety	1-4
Units with Hydraulics	1-5
Crush Points	1-5
Facer Blades are Sharp	1-5
Have Tires Properly Serviced.	1-6
Do Not Tow Fusion Machine at Speeds Greater than 5 MPH	1-6
Fusion Procedures	1-6
Heater is Hot.	1-6
Periodically Check Temperature.	1-7
Positioning Fusion Machine.	1-7

Overview

Theory of Heat Fusion	2-1
Carriage Assembly	2-2
Chassis.	2-2
Gas Powered Units	2-3
Tac and Hour Meter.	2-3
Electrical Units	2-4
Volt Meter	2-4
Power for Heater	2-4
Oil Reservoir	2-5
Hydraulic Manifold Block	2-5
Filter.	2-5
Hydraulic Cylinders	2-6
Pipe Lift	2-6
Facer	2-7
Insulated Heater Stand	2-7
Heater	2-8

COPYRIGHT © 2008
 McELROY MANUFACTURING, INC.
 Tulsa, Oklahoma

All product names or trademarks are property of their respective owners. All information, illustrations and specifications in this manual are based on the latest information available at the time of publication. The right is reserved to make changes at any time without notice.



Table of Contents



Operation

Read Before Operating	3-1
Check Oil Level	3-1
Connecting Electric Unit to Power	3-1
Gas Powered Units	3-1
Prepare Heater	3-2
Set up Pipe Supports	3-2
Install Clamping Inserts	3-3
Check Hydraulic Pressure	3-3
Loading Pipe into Machine	3-4
Positioning Pipe into Machine	3-4
Facing the Pipe	3-4
Remove Facer	3-5
Position Carriage for Heater Insertion	3-6
Check Heater Temperature	3-6
Select the Fusion Position	3-6
Inserting Heater	3-7
Heating the Pipe	3-7
Fusing the Pipe	3-8
Opening Movable Jaws	3-8
Opening Fixed Jaws	3-9
Raise Pipe	3-9
Position Pipe for Next Joint	3-9
Install Next Piece of Pipe	3-9

Special Operations - In Ditch

Outrigger	4-1
Remove Facer from No.412 and No.618 Machine	4-1
Remove Carriage Assembly from the Chassis	4-2
Remove 3-Jaw Assembly from the Carriage	4-3
Manual Facer Operation	4-4
Removing Top Jaws	4-4
Lower 3-Jaw or 4-Jaw Carriage into Ditch	4-5
Clamp Carriage Assembly to Pipe	4-6
Lower Facer into Ditch	4-7
Make Fusion Joint	4-7
Remove Carriage Assembly from Ditch	4-7
Reassemble Fusion Machine	4-7

Lifting Fusion Machine

Heavy Overhead Load	5-1
Crush Points	5-1
Lifting Sling	5-1
Lifting Safety	5-1
Lift Equipment	5-2



Table of Contents



Maintenance

Preventative Maintenance	6-1
Washing the Machine	6-1
Check Hydraulic Fluid	6-1
Check Hydraulic Fluid and Filter	6-1
Check Guage	6-2
Clean Jaws and Inserts	6-2
Clean Thrust Bearings	6-2
Clean Eyebolt Threads	6-2
Bleeding Air from Hydraulic System	6-3
Facer Blades	6-3
Clean Heater Surfaces	6-3
Installing Butt Fusion Heater Plates	6-4
Adjusting Heater Temperature	6-4
Indicator Light	6-4
Fasteners Must be Tight	6-5

Machine Maintenance Checklist

Maintenance Checklist	7-1
---------------------------------	-----

Determining Fusion Pressure

Determining Fusion Pressure	8-1
---------------------------------------	-----

Hydraulic Fluids

Hydraulic Fluid Characteristics	9-1
---	-----

Specifications

Fusion Machine Specifications	10-1
Generator Sizing Form	10-2



Fusion Equipment Safety



Safety Alerts

This hazard alert sign  appears in this manual. When you see this sign, carefully read what it says. **YOUR SAFETY IS AT STAKE.**

You will see the hazard alert sign with these words: **DANGER**, **WARNING**, and **CAUTION**.



WR00051-11-30-92



Indicates an imminently hazardous situation which, if not avoided, will result in death or serious injury.



Indicates a potentially hazardous situation which, if not avoided, could result in death or serious injury.



Indicates a hazardous situation which, if not avoided, may result in minor or moderate injury.

In this manual you should look for two other words: **NOTICE** and **IMPORTANT**.

NOTICE: can keep you from doing something that might damage the machine or someone's property. It may also be used to alert against unsafe practices.

IMPORTANT: can help you do a better job or make your job easier in some way.



TX00030-12-1-92

Read and Understand

Do not operate this equipment until you have carefully read, and understand the "Safety" and "Operation" sections of this manual, and all other equipment manuals that will be used with it.

Your safety and the safety of others depends upon care and judgment in the operation of this equipment.

Follow all applicable federal, state, local, and industry specific regulations.

McElroy Manufacturing, Inc. cannot anticipate every possible circumstance that might involve a potential hazard. The warnings in this manual and on the machine are therefore not all inclusive. You must satisfy yourself that a procedure, tool, work method, or operating technique is safe for you and others. You should also ensure that the machine will not be damaged or made unsafe by the method of operation or maintenance you choose.



WR00052-12-1-92

TX00031-12-8-92



Fusion Equipment Safety



General Safety

Safety is important. Report anything unusual that you notice during set up or operation.

LISTEN for thumps, bumps, rattles, squeals, air leaks, or unusual sounds.

SMELL odors like burning insulation, hot metal, burning rubber, hot oil, or natural gas.

FEEL any changes in the way the equipment operates.

SEE problems with wiring and cables, hydraulic connections, or other equipment.

REPORT anything you see, feel, smell, or hear that is different from what you expect, or that you think may be unsafe.

TX00114-4-22-93



SAFE1ST-12-22-92

Wear Safety Equipment

Wear a hard hat, safety shoes, safety glasses, and other applicable personal protective equipment.

Remove jewelry and rings, and do not wear loose-fitting clothing or long hair that could catch on controls or moving machinery.

TX00032-4-7-93

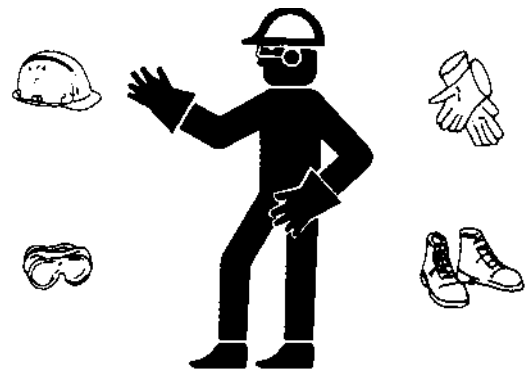

WR00053-1-2-2-92

Fuel Handling

⚠ DANGER Gasoline and diesel fuel are extremely flammable and their vapors will explode if ignited.

Do not fill the fuel tank while the engine is hot or running, as spilled fuel could ignite.

Refuel in a well ventilated area. Do not smoke or allow flames or sparks in the area where the engine is refueled, or where gasoline is stored.

Do not start the engine near spilled fuel. Wipe up spills immediately.

Make sure the fuel tank cap is closed and properly secured.

Avoid repeated or prolonged contact with skin or breathing of vapor.

TX00953-2-19-97

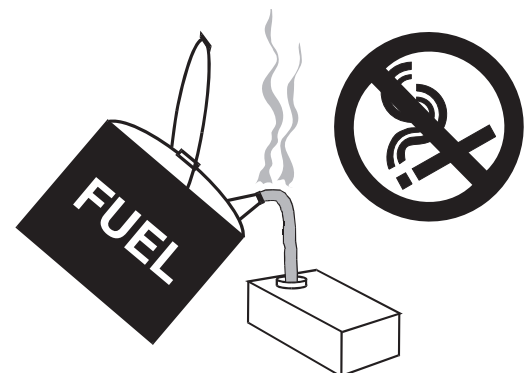

CD00065-2-19-97



Fusion Equipment Safety



Units With Engines

⚠ DANGER

Combustion engines can cause explosions when operated in a hazardous environment. Do not operate gas or diesel powered machines in a hazardous environment.

When operating in a hazardous environment, keep engine and chassis in a safe area by using hydraulic extension hoses.

Help prevent fires by keeping machine clean of accumulated trash, debris and facer shavings.

TX01266-2-21-97



WR00080-4-12-93

Carbon Monoxide

⚠ DANGER

Engine exhaust gases contain poisonous carbon monoxide. Carbon monoxide can cause severe nausea, fainting and death. Avoid inhaling exhaust fumes and never run the engine in a closed or confined area.

TX00954-5-14-96



WR00093-5-14-96

Heater Is Not Explosion Proof

⚠ DANGER

This heater is not explosion proof. Operation of heater in a hazardous environment without necessary safety precautions will result in explosion and death.

If operating in a hazardous environment, the heater should be brought up to temperature in a safe environment, then **unplugged before entering** the hazardous atmosphere for fusion.

TX00100-9-16-94



WR00034-11-30-92

Electric Motors are Not Explosion Proof

⚠ DANGER

Electric motors are not explosion proof. Operation of these components in a hazardous environment without necessary safety precautions will result in explosion and death.

When operating in a hazardous environment, keep pump motor and chassis in a safe area by using hydraulic extension hoses.

TX00424-8-12-94



WR00080-4-12-93



Fusion Equipment Safety



Battery



Do not expose the battery to flames or electrical sparks. Hydrogen gas generated by battery action is explosive. Blindness or serious injury can result from an exploding battery.



CD001769-14-95



Do not allow battery fluid to contact your skin, eyes, fabrics, or painted surfaces. Sulfuric acid can cause burns. After touching a battery or battery cap, do not touch or rub your eyes. Thoroughly wash your hands. If the acid contacts your eyes, skin or clothing, immediately flush with water for at least 15 minutes and seek medical attention.



CD001779-14-95

TX00650-9-14-95

Electrical Safety



Always ensure power cords are properly grounded. It is important to remember that you are working in a wet environment with electrical devices. Proper ground connections help to minimize the chances of an electric shock.



WR00055-4-7-93

Frequently inspect electrical cords and unit for damage. Have damaged components replaced and service performed by a qualified electrician.

Do not carry electrical devices by the cord.

NOTICE: Always connect units to the proper power source as listed on the unit, or in the owner's manual. On units with two power cords, plug each cord into separate power circuits. Do not plug into both outlets of one duplex receptacle.

NOTICE: Disconnect the machine from the power source before attempting any maintenance or adjustment.



WR00025-11-30-92

TX00105-4-12-93



Fusion Equipment Safety



Units With Hydraulics

Although the hydraulic pressures in this machine are low compared to some hydraulically operated equipment, it is important to remember that a sudden hydraulic oil leak can cause serious injury, or even be fatal if the pressure is high enough.

WARNING Escaping fluid under pressure can penetrate the skin causing serious injury. Keep hands and body away from pinholes which eject fluid under pressure. Use a piece of cardboard or paper to search for leaks. If any fluid is injected into the skin, it must be immediately removed by a doctor familiar with this type of injury.

NOTICE: wear safety glasses, and keep face clear of area when bleeding air from hydraulic system to avoid spraying oil into eyes.



WR00078-4-8-93

TX00110-8-23-95

Crush Points

WARNING Hydraulically operated jaws are operated under pressure. Anything caught in the jaws will be crushed. Keep fingers, feet, arms, legs, and head out of the jaw area. Always check pipe alignment with a pencil or similar object.

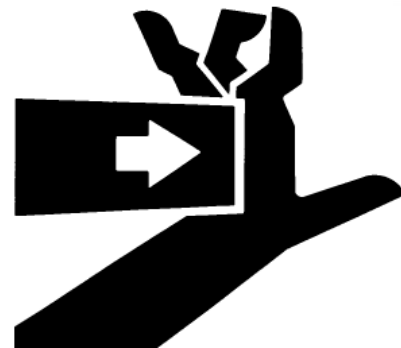

WR00012-12-4-92

TX00103-4-6-93

Facer Blades Are Sharp

WARNING Facer blades are sharp and can cut. Never attempt to remove shavings while the facer is running, or is in the facing position between the jaws. Use care when operating the facer, and when handling the unit.

NOTICE: Disconnect power from the facer, and remove the facer blades before attempting any maintenance or adjustment.

NOTICE: Never extend the blade beyond the inner or outer circumference of the facer.

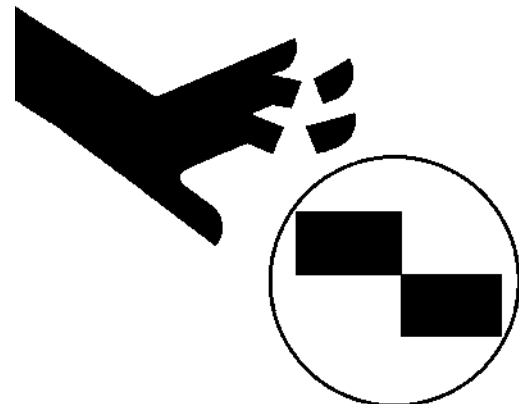

WR00073-4-6-93

TX02378-1-24-05



Fusion Equipment Safety



Have Tires Properly Serviced



Failure to follow proper procedures when mounting a tire on a wheel or rim can produce an explosion which may result in serious injury or death. Have tires mounted by someone that is experienced, and has the proper equipment to perform the job safely.

TX00118-4-22-93

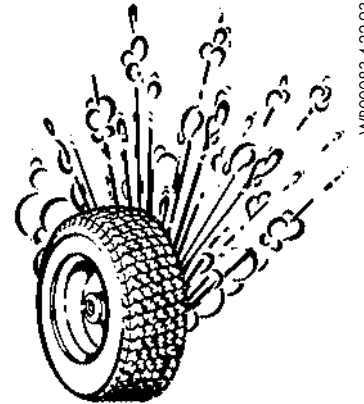

WR00083-4-22-93

Do Not Tow Fusion Machine At Speeds Greater Than 5 MPH



The chassis is not designed for over-road towing. Towing at speeds greater than five miles per hour can result in machine damage as well as injury. Always transport the machine by flat bed truck or similar means, and make sure that unit is properly secured.

TX00101-4-12-93

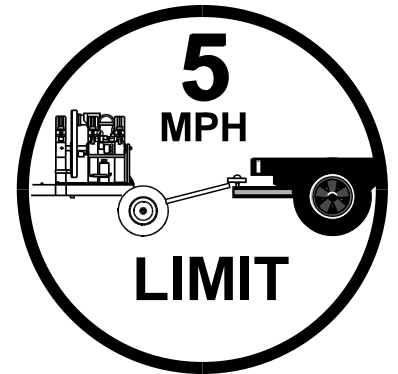

CD00189-1-24-96

Fusion Procedures

Obtain a copy of the pipe manufacturer's procedures for the pipe being fused. Follow the procedure carefully, and adhere to all specified parameters.



Failure to follow pipe manufacturer's procedure could result in a bad joint. Always follow pipe manufacturer's procedures.

TX00113-4-12-93

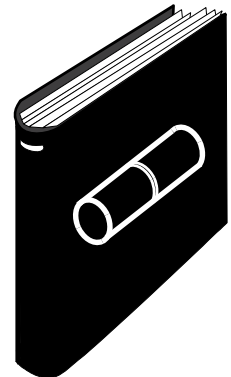

WR00079-1-24-96

Heater Is Hot



The heater is hot and will burn clothing and skin. Keep the heater in its insulated heater stand or blanket when not in use, and use care when heating the pipe.

NOTICE: Use only a clean non-synthetic cloth such as a cotton cloth to clean the heater plates.

TX00104-8-12-94



WR00030-2-10-93



Fusion Equipment Safety



Periodically Check Temperature

NOTICE: Incorrect heating temperature can result in bad fusion joints. Check heater plate surface temperature periodically with a properly calibrated pyrometer, and make necessary adjustments.

The thermometer on heaters indicates internal temperature, and should be used as a reference only.

TX00107-11-13-95

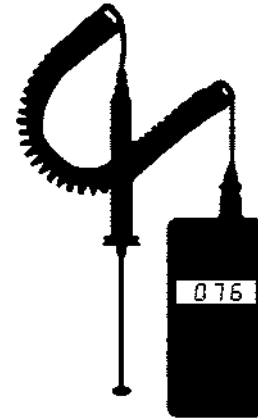

WR00077-1-24-96

Positioning Fusion Machine

Place fusion machine on as level ground as possible, and set the brake on the rear wheel. If it is necessary to operate machine on unlevel grade, chock the wheels and block the unit to make it as stable as possible.

TX00112-9-15-94

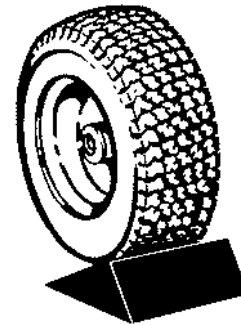

WR00076-4-7-93

Theory of Heat Fusion

The principle of heat fusion is to heat two surfaces to a designated temperature, and then fuse them together by application of force. This pressure causes flow of the melted materials, which causes mixing and thus fusion. When the polyethylene material is heated, the molecular structure is transformed from a crystalline state into an amorphous condition. When fusion pressure is applied, the molecules from each Polyethylene part mix. As the joint cools, the molecules return to their crystalline form, the original interfaces are gone, and the fitting and pipe have become one homogeneous unit. The joint area becomes as strong as the pipe itself in both tensile and pressure conditions.

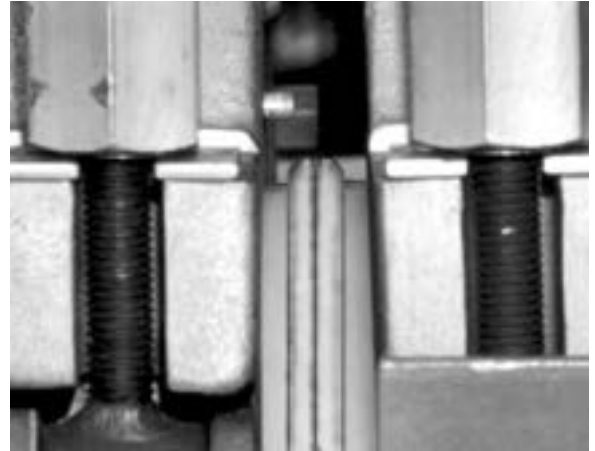

PH00363B9-12.94

The principle operations include:

- Clamping** The pipe pieces held axially to allow all subsequent operations to take place.
- Facing** The pipe ends must be faced to establish clean, parallel mating surfaces perpendicular to the centerline of the pipes.
- Aligning** The pipe ends must be aligned with each other to minimize mismatch or high-low of the pipe walls.
- Heating** A melt pattern that penetrates into the pipe must be formed around both pipe ends.
- Joining** The melt patterns must be joined with a specified force. The force must be constant around the interface area.
- Holding** The molten joint must be held immobile with a specified force until adequately cooled.
- Inspecting** Visually examine the entire circumference of the joint for compliance with standards established by your company, customer, industry, federal, state, or local regulations.

Each pipe manufacturer has a slightly different approach for fulfilling the heating, joining, and holding phases, but the end result is the same – a fusion joint that is as strong or stronger than the pipe itself.



Overview



Carriage Assembly

The carriage assembly consists of two fixed jaws and two hydraulically operated movable jaws bolted to the skid. For remote operation the carriage can be set in ditch and connected to the machine with optional hydraulic extension hoses. The carriage assembly (A) can be disconnected from the chassis (B) and removed for remote operation. The optional extension hose kit is required for this operation.

For tight installations the outer fixed jaw and skid can be removed from the carriage for an even more compact fusion unit.

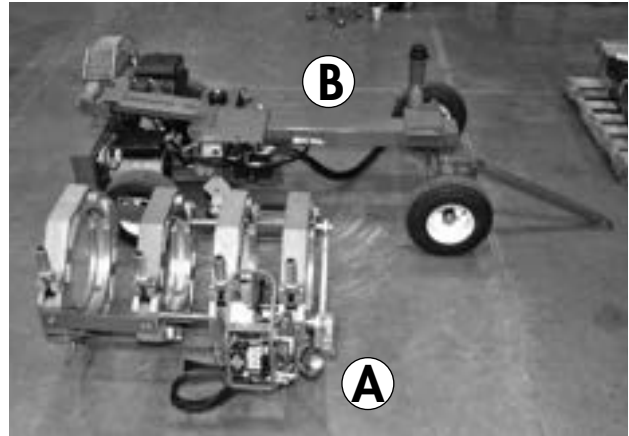

PH02588-09-18-03

TX01891-11-15-00



PH02592-09-18-03

Chassis

The carriage assembly is mounted on a four wheel chassis for mobility and movement along the pipe line.

There is a wheel lock on the right rear wheel to prevent rolling.

⚠ WARNING Towing at speeds greater than 5 mph can result in machine damage as well as injury. Always transport the machine by flatbed truck or similar means.

The tongue on the tow bar has a ring to slip over a ball hitch so that the machine may be conveniently maneuvered at the job site.

The chassis is not designed for over-road towing.



PH03051-6-20-05



PH02597-09-18-03

TX02214-09-17-03



Overview



Gas Powered Units

Read the operating and maintenance instructions for the engine before operating.



PH02599-09-18-03

The engine has a choke control and key ignition for easy electric starting.



PH02600-09-18-03

TX01257-2-19-97

Tac and Hour Meter

When the unit is running, the engine RPM's are displayed. When the unit is not running, total hours of engine operation are displayed.



PH01055-2-19-97

TX01267-2-21-97



Overview



Electrical Units

Located on the top of the electrical box are power on and power off buttons and an hour meter that indicates how many hours the unit has been in operation.

A motor circuit breaker is included in the electrical box.

TX01085-8-16-96



PH00919-8-16-96

Volt Meter

The volt meter displays incoming volts of electricity to the machine.

The volt meter selector switch is next to the volt meter. This switch allows selection of each incoming phase of a 3-phase electrical system.

NOTICE: Low voltage will damage unit. Connect unit to adequate electrical power source. Ensure proper ground for electrical system.

If unit fails to start, check to see if the light on the reverse phase relay is on. If not, disconnect the power source and switch any two incoming power leads and try again. If the unit still doesn't start and the light is on, call McElroy personnel for assistance. The reverse phase relay ensures correct rotation of the pump motor so damage to the hydraulic system does not occur.

TX01086-8-16-96

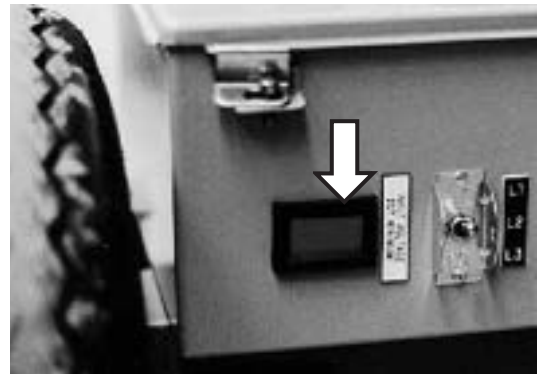

PH00637-12-95

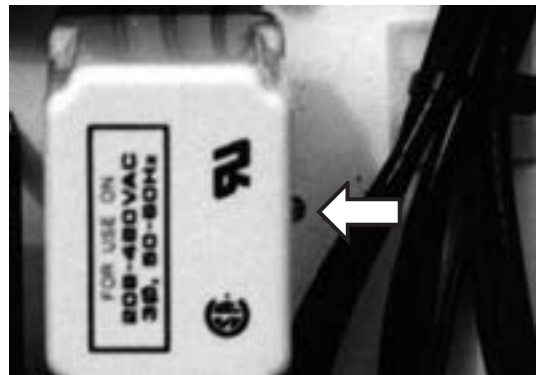

PH00921-8-16-96

Power for Heater

A receptacle is located on the chassis frame to supply power to the heater.

TX01087-8-16-96



PH02596-09-18-03



Overview



Oil Reservoir

The reservoir is incorporated in the chassis. The oil level should remain visible in the **sight gauge** in the side of the filler spout. Never allow dirt or other foreign matter to enter the open tank. Refer to the "Hydraulic Fluids" section of this manual for hydraulic oil recommendations.

TX00353-9-16-94



PH02602-09-18-03

Hydraulic Manifold Block

Mounted on this block are a carriage directional control valve, a pressure reducing selector valve, three pressure reducing valves, and a pressure gauge.

- A) The carriage control valve, mounted on the top of the manifold, determines whether the carriage is moving left, right, or is in neutral.
- B) A pressure gauge is mounted on top of the manifold.
- C) The selector valve, mounted on the front of the manifold, selects a reduced pressure from one of the pressure reducing valves.

Each pressure reducing valve is labeled with a different function:

- D) The top valve adjusts facing pressure to a maximum of 400 psi.
- E) The middle valve adjusts heating pressure to a maximum of 400 psi.
- F) The bottom valve adjusts fusion pressure to a maximum of 1500 psi.

TX00819-12-21-95

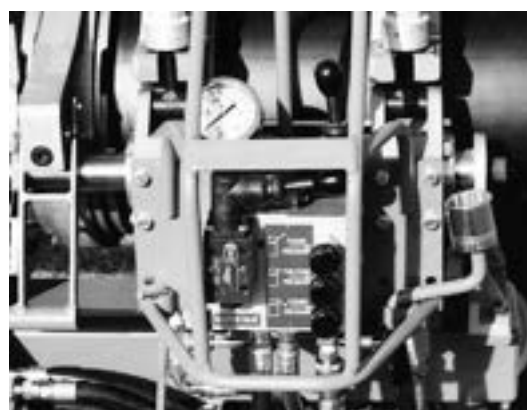

PH01030-2-20-97

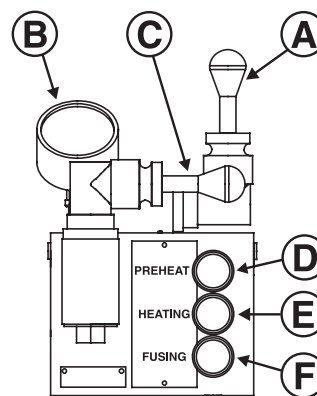

CD00138F9-12-94

Filter

This machine is equipped with a 10 Micron filter located in the return line to the reservoir.

TX01269-2-21-97



PH02603-09-18-03



Overview



Hydraulic Cylinders

HIGH FORCE hydraulic carriage cylinders are painted green. High force cylinders are used when higher interfacial pressures are required, when handling heavy wall pipe, or when large drag factors need to be overcome.

MEDIUM FORCE cylinders are painted orange and have approximately half the total effective piston area as High Force cylinders. The cylinders move faster and are normally used for medium density pipe and when lower interfacial pressures are used.

LOW FORCE Cylinders are painted yellow. These cylinders should be selected when fusing pipe with a very low interfacial pressure (22 psi).

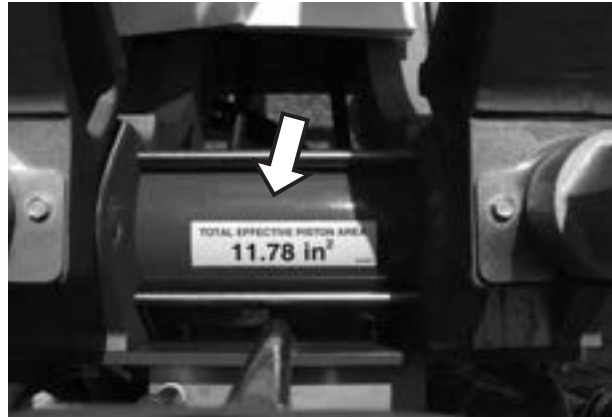

PH02573-09-18-03

TX01270-2-21-97

Pipe Lift

A pipe lift is provided to assist in pipe handling. The lift is activated by a hydraulic valve.



PH02575-09-18-03



PH02574-09-18-03

TX00813-12-18-96



Overview



Facer

The facer is a McElroy Rotating Planer-Block design. The block rotates on a ball bearing and is chain driven by a hydraulic motor.

When fusing 4" and 6" diameter pipe on the No.412 or No.618 move the facer blades to the inboard position.

NOTICE: Never extend the blade beyond the inner or outer circumference of the facer.

TX02533-6-20-05



PH02576-09-18-03

Insulated Heater Stand

The heater should always be stored in the insulated heater stand or blanket for protection of the operator and to minimize heat loss and risk of mechanical damage.

TX00363-9-15-94



PH02313-6-28-02

Heater

⚠ DANGER

This heater is not explosion proof! Operation of heater in a hazardous environment can result in explosion and death.

The heater temperature is controlled by a microprocessor.

The heater has a green indicator light which will flash on and off. This indicates that the controller is operating normally. If the green indicator is not flashing then the controller may not be operating properly. If this occurs, disconnect power and have the heater repaired by an McElroy Authorized Service Center.

It has a red indicator light on the handle at the bottom of the temperature scale. When the heater is plugged in and preheating the light glows steadily until the set temperature is reached. The light then goes off and on slowly as the heater maintains temperature.

Coated butt fusion heater plates are available for non-coated heaters.

NOTICE: Non-coated heaters should never be used without butt fusion heater plates installed.

To prevent a build-up of pipe residue from accumulating on the heater plates (loss of surface temperature and pipe sticking may result), the heater plates should be cleaned with a non-synthetic cloth before and after every fusion joint.



PH02334-6-28-02



PH02313-6-28-02



PH02333-6-28-02



Operation



Read Before Operating

Before operating this machine, please read this manual thoroughly, and keep a copy with the machine for future reference.

Return manual to the protective storage box when not in use. This manual is to be considered part of your machine.

TX00401-9-15-94



STOP-112-28-95

Check Oil Level

Check oil level in sight gauge on filler spout and add oil if necessary.

Refer to the "Hydraulic Fluids" section of this manual for hydraulic oil recommendations.

TX00364-9-15-94

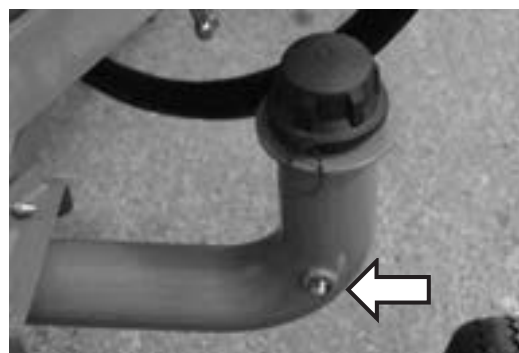

PH02602-09-18-03

Connecting Electric Unit to Power



All electrical equipment and power sources must be located in a nonhazardous location. Failure to do so can result in explosion and death.

Plug machine's electrical cord into a proper power source.

Open fuser valve and disconnect heater before turning unit on.

TX00817-12-20-95

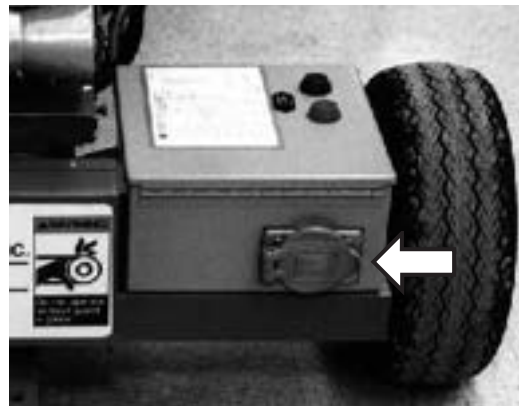

PH00647-12-20-95

Gas Powered Units

Read the operating and maintenance instructions for the engine before operating.

Open fuser valve and disconnect heater before starting engine.

Pull choke control out and turn ignition key to start engine.

Release key when engine starts.

Gradually push choke control in as engine starts and warms up.

TX01260-2-20-97



PH02600-09-18-03



Prepare Heater



Heater Is Not Explosion Proof. Operation of heater in a hazardous environment without necessary safety precautions will result in explosion and death.

If operating in a hazardous environment, heater should be brought up to temperature in a safe environment, then unplugged before entering the hazardous atmosphere for fusion.

Install butt fusion heater plates.

NOTICE: Non-coated heaters should never be used without butt fusion heater plates installed. Refer to the "Maintenance" section of this manual for installation procedure.

Place heater in insulated heater stand.

Plug heater into outlet on machine.

Allow heater to warm-up to operating temperature.

Refer to the "Maintenance" section of this manual for instructions how to adjust heater temperature.



PH023346-28-02



PH010932-20-97

TX00366-9-16-94

Set up Pipe Supports

Set up pipe stands and adjust height so the pipe is in line with the jaws.



PH010332-20-97

TX00367-9-15-94



Operation



Install Clamping Inserts

Select and install appropriate clamping inserts for the pipe that is being fused.



PH00304-9-24-93

TX00368-9-15-94

Check Hydraulic Pressure

The pressure gauge on the manifold block indicates the pressure at the carriage valve. How much pressure depends on the position of the selector valve and the pressure set on the specific pressure reducing valve. With the selector valve up, the facing pressure can be set. It may be necessary to adjust the carriage speed, while facing, with the top pressure reducing valve to control facing speed.

Shift the selector valve to the center position, and set the heating pressure (if required). If heating pressure is not required, set the pressure reducing valve at its lowest setting, or the drag pressure, whichever is higher.

With the selector valve in the down position, the fusion pressure can be set.

The heating and fusion pressures can be calculated using the enclosed Fusion Pressure Calculator. Always add drag pressure to the calculated gauge pressure. Drag pressure should be determined using the following procedure:

After facing the pipe, move the carriage so that the pipe ends are approximately 2" apart.

Shift the carriage control valve to the middle (neutral) position.

Select the heating mode, and adjust the middle pressure reducing valve to its lowest pressure by turning the valve counterclockwise.

Shift the carriage control valve to the left.

Gradually increase the pressure by turning the valve clockwise. Increase the pressure until the carriage moves.

Quickly reduce the heating pressure valve counterclockwise until the carriage is just barely moving.

Record this actual drag pressure.

Take the pressure, determined from the Fusion Pressure Calculator, and add the actual measured drag pressure. This will be the actual fusion pressure to set with the bottom pressure reducing valve.

TX01939-9-22-08

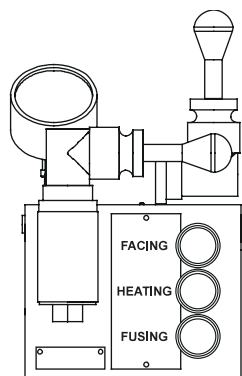

CD00138B-9-12-94



PH01960-5-24-01



Loading Pipe Into Machine

Clean the inside and outside of pipe ends that are to be fused.

Open the upper jaws and insert pipe in each pair of jaws with applicable inserts installed. Let the ends of the pipe protrude more than 1" past the face of the jaws.

TX01094-8-20-96

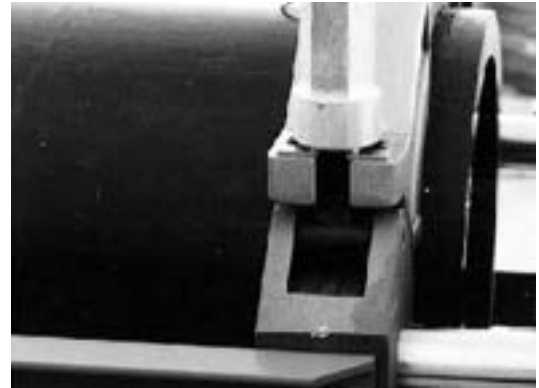

PH00715-2-12-96

Positioning Pipe In Machine

Swing the facer into place. With the carriage control valve lever, move the carriage toward the fixed jaws, while watching the gap at each end of the facer rest buttons. When the pipe is in contact with the facer, this gap indicates the amount of material that will be trimmed from the pipe end. Assure sufficient material will be removed for a complete face off. Tighten the clamp knobs on the outside jaws. Hand tighten the inside clamp knobs.

TX00372-9-15-94

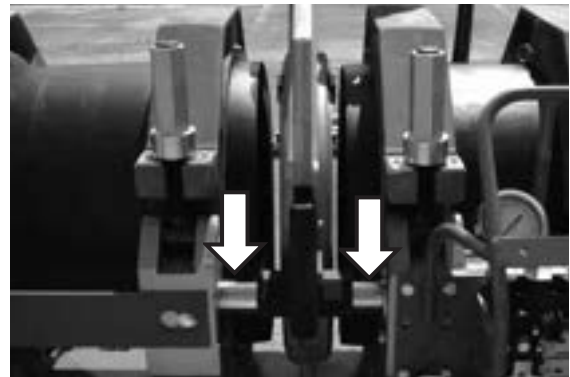

PH02577-09-18-03

Facing the Pipe

Move the carriage to the right.

Open the ball valve on the facer motor.

Assure the selector valve handle is up in the facing position.

Move the carriage control valve to the left.

If the facer stalls, adjust the facing pressure so the facer continues to cut.

IMPORTANT: When facing heavy wall pipe, it may be necessary to increase the system pressure to 1000 psi.

IMPORTANT: When drag pressure exceeds 300 psi it is necessary to move the carriage to the left bringing the pipe ends into contact with the facer before opening the facer valve.

Let the carriage bottom out on facer stops. Turn facer off. Move the carriage to the right so the facer can be removed.

TX00372-11-3-94

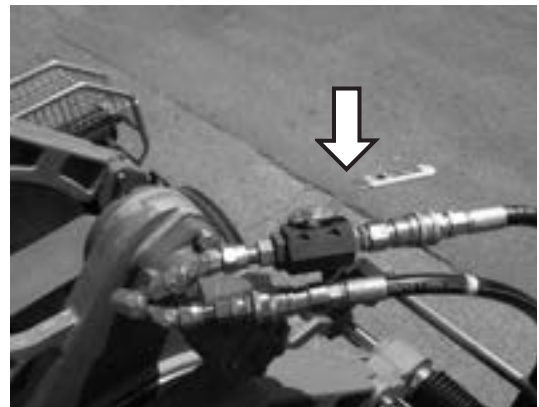

PH02578-09-18-03

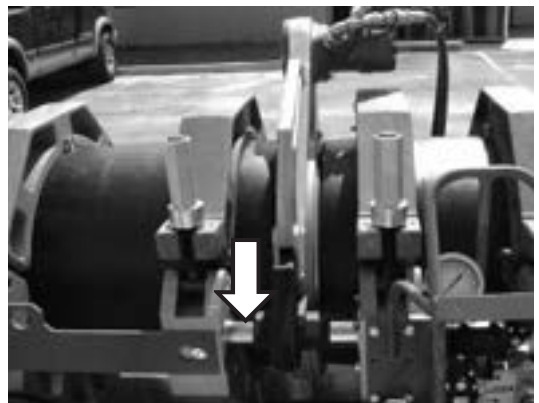

PH02579-09-18-03



Operation



Remove Facer

Release the trigger lock, and swing the facer out to the storage position.

Remove chips from pipe ends.

Do not touch faced pipe ends.

Inspect both pipe ends for complete face off. If the face off is incomplete, return to **Loading Pipe into Machine**.

Move the carriage to the left until ends of pipe butt together.

Check pipe joint for proper alignment.

⚠ WARNING Do not use finger to check for hi/lo (misalignment). The unit is under pressure, and slippage could result in crushed fingers. Always keep hands clear of the jaw area.

If pipe is not lined up, tighten the high side jaw to bring into alignment.

IMPORTANT: Always tighten the side that is higher, never loosen the low side.

When the pipe is properly aligned tighten outside clamps to insure against slippage.

Ensure there is no unacceptable gap between the pipe ends. If there is an unacceptable gap, return to **Loading Pipe into Machine**.

NOTICE: When clamping, do not over-tighten the clamp knobs because machine damage can result. Check to see if there is space between the upper and lower jaws. If the two jaws are touching, do not continue to tighten.

Bring the pipe ends together under fusion pressure to check for slippage. If slippage occurs, return to **Loading Pipe into Machine**.

TX00373-10-12-95

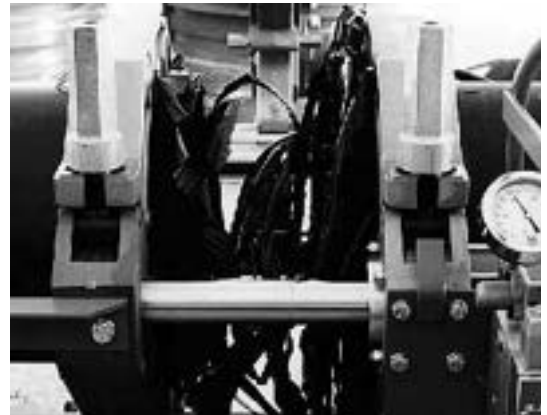

PH00713-2-12-96



PH00366-9-12-94

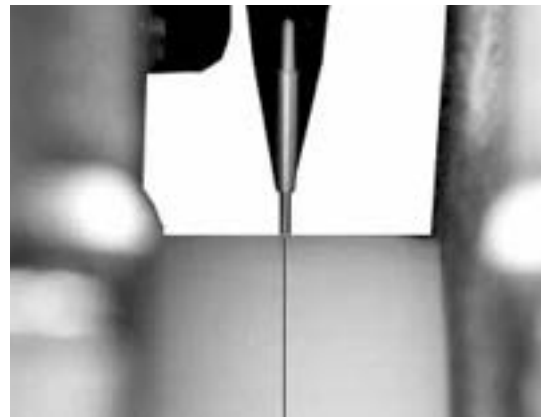

PH00357-9-12-94

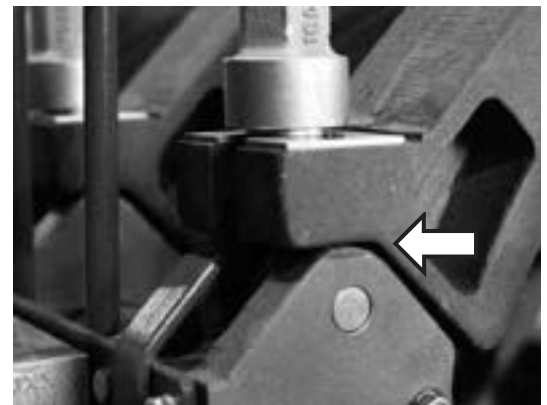

PH00865-6-20-96

Position Carriage for Heater Insertion

Move carriage to the right to open a gap large enough to insert the heater.

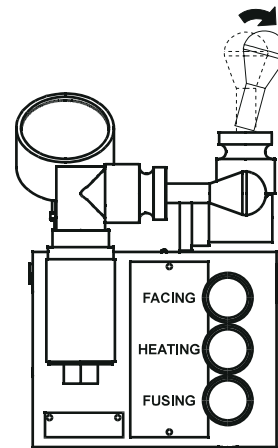

CD001908-2-14-96

TX00374-9-15-94

Check Heater Temperature

CAUTION

Incorrect heating temperature can result in questionable fusion joints. Check heater plates periodically with a pyrometer and make necessary adjustments.

Check heater surface temperature.

Refer to the pipe manufacturer's recommendations for proper heater temperature.

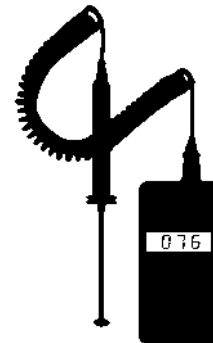

WR00077-4-16-93

IMPORTANT: The dial thermometer on the heater indicates internal temperature which varies from the actual surface temperature.

The dial thermometer can be used as reference once the surface temperature has been verified.



PH01094-2-20-97

TX00375-11-1-94

Select the Fusion Position

Move selector valve handle down to the fusing position.

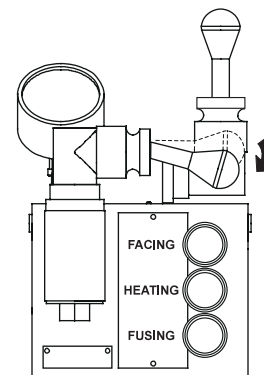

CD001912-14-96

TX00376-9-15-94



Operation



Inserting Heater



Heater Is Not Explosion Proof. This unit is not explosion proof. Operation of heater in a hazardous environment without necessary safety precautions will result in explosion and death.

If operating in a hazardous environment, heater should be brought up to temperature in a safe environment, then unplugged before entering the hazardous atmosphere for fusion.

Use a clean non-synthetic cloth to clean the butt fusion heater plate surfaces.

Verify heater temperature by noting the reading on the dial thermometer.

Insert heater between the pipe ends.



PH02333-6-28-02



PH01094-2-20-97

TX00377-9-15-94

Heating the Pipe

- A) Move the carriage to the left, bringing the heater into contact with both pipe ends.
- B) Move selector valve to center position.
- C) If heating pressure is not required, allow the pressure to stabilize at the lowest setting and return carriage control valve to neutral position.

A

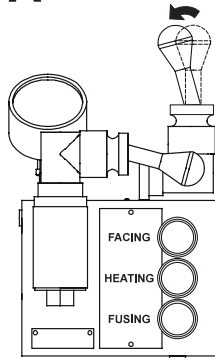

B

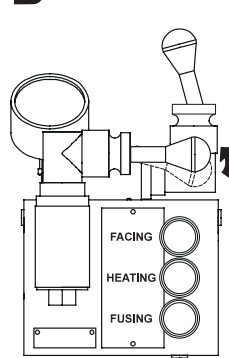

C

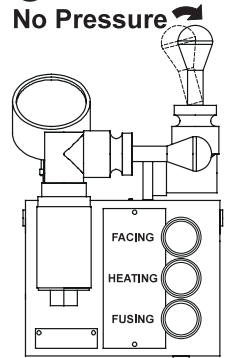

CD00140-2-14-96

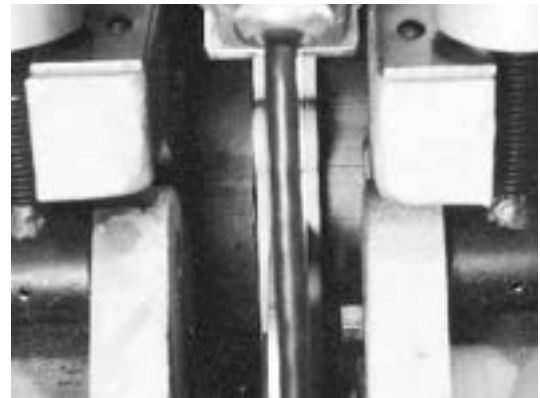

PH01095-2-20-97

TX00378-9-15-94

Fusing the Pipe

⚠ CAUTION

Failure to follow pipe manufacturer's heating time, pressure, and cooling time may result in a bad joint.

After following the pipe manufacturer's suggested heating procedure:

- A) Shift carriage control valve to neutral position, if it is not already in that position.
 - B) Shift the selector valve down to fusion position.

 - C) Move the carriage to the right just enough to remove the heater.
- Quickly remove the heater.**
- D) Quickly move the carriage to the left, bringing the pipe ends together under the pipe manufacturer's recommended pressure.

Allow joint to cool under pressure according to pipe manufacturer's recommendation.

TX02305-6-1-04

A

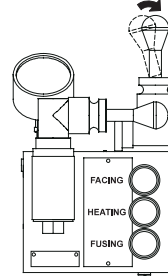

B

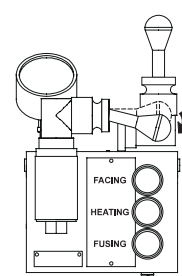

C

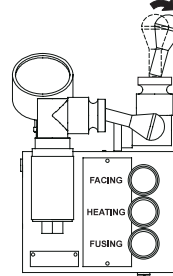

D

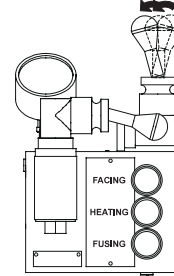

CD00141A2-1-4-96

CD00141B2-1-4-96



PH00363B-1-4-96

Opening Movable Jaws

After the joint has cooled for the pipe manufacturer's recommended time, shift the carriage control valve to the neutral position.

Loosen all clamp knobs, and move carriage to the right far enough to open the jaw nearest the facer.

Open the movable jaws.

TX00380-9-15-94



PH01096-2-20-97



Operation



Opening Fixed Jaws

Open the fixed jaws.

TX00381-9-16-94



PH02580-09-18-03

Raise Pipe

Raise the joined pipe using the hydraulic pipe lift.

TX00818-12-21-95



PH02575-09-18-03

Position Pipe for Next Joint

Move the fusion machine to end of pipe, or pull the pipe through the jaws until the end of the pipe is protruding more than 1" past the jaw face of the fixed jaw.

TX01091-8-20-96

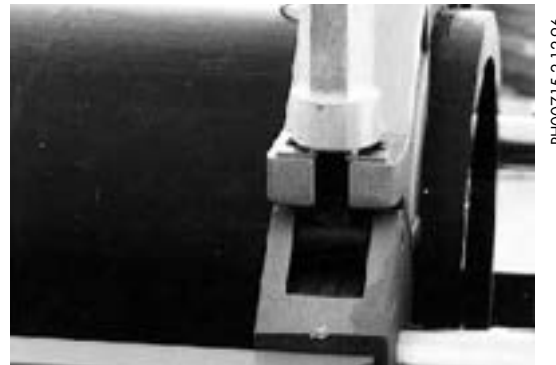

PH00715-2-12-96

Install Next Piece of Pipe

Insert a new piece of pipe in movable jaws and repeat all previous procedures.

TX00384-10-12-95



PH02577-09-18-03



Special Operations - In-Ditch



Outrigger

The outrigger is an arm that is retractable and adds support to the carriage assembly when opening the jaws and pivoting the facer away from the carriage.

To extend or retract the outrigger, press the locking button near the base of the outrigger and push or pull the arm until the button snaps to the locked position.

NOTICE: Never use the outrigger to lift or move the carriage.



PH02698-04-29-04



PH02699-04-29-04

TX02304-04-29-04

Remove Facer From No.412 and No.618 Machine

Remove rear guide rod bracket.

Remove facer locking bolts.

Lift facer out of the carriage and set on cardboard or wood blocks off of ground.

Attach rear guide rod bracket in the position shown.

TX01992-1-10-02



PH01933-11-15-00



PH01936-11-15-00



PH01907-11-15-00



Remove Carriage Assembly from the Chassis



This equipment is not explosion proof. Operation of this equipment in a hazardous environment without necessary safety precautions will result in explosion and death. See safety section.

There are two sets of hydraulic hoses. One set connects to the carriage hoses on the machine and to the carriage. The other set connects to the facer hoses on the machine and to the facer.

Disconnect both sets of hoses.

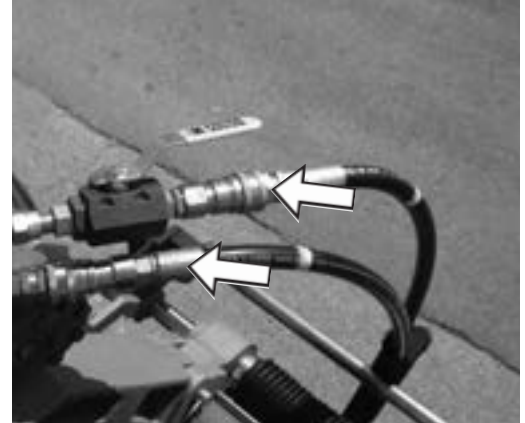

PH02578-09-18-03

The carriage can be easily removed from the machine for fusing pipe on the ground or in the ditch. For especially tight conditions it is also possible to remove the outer fixed jaws and skid. The facer can be removed from the pivot shaft and used manually.

Remove Pin.



PH01941-11-15-00

Attach lifting sling to the lifting points and the manifold bracket, then lift the carriage assembly.

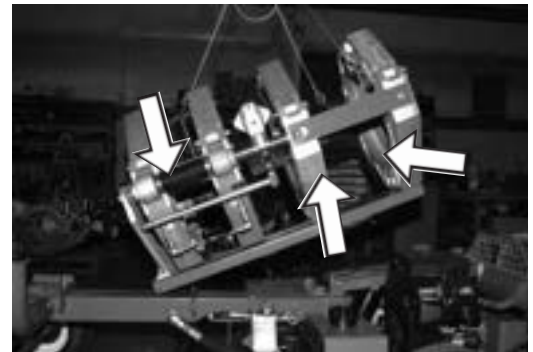

PH02586-09-18-03



Special Operations - In-Ditch



Remove 3-Jaw Assembly from the Carriage

Remove braces from inner fixed jaw.



PH01939-11-15-00

Remove the four bolts holding carriage assembly to the chassis with the wrench provided.



PH01945-11-15-00

Attach lifting strap as shown and lift the carriage assembly.

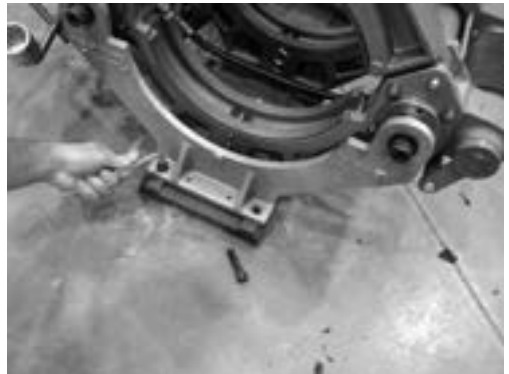

PH01947-11-15-00

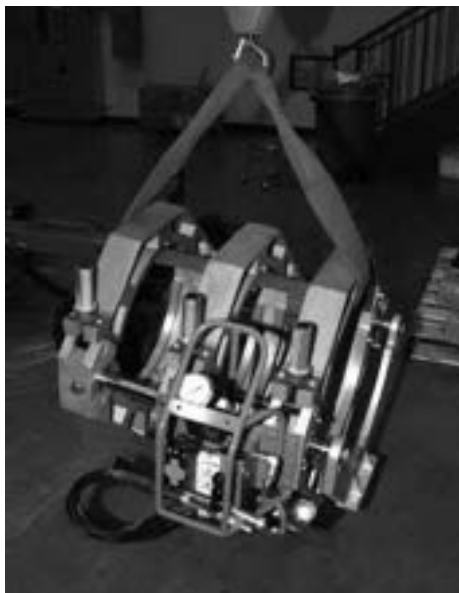

PH02591-09-18-03

TX01875-11-8-00



PH02592-09-18-03



Manual Facer Operation

Lift as shown.



PH0258409-18-03

Lock onto back guide rod, then latch on front guide rod.

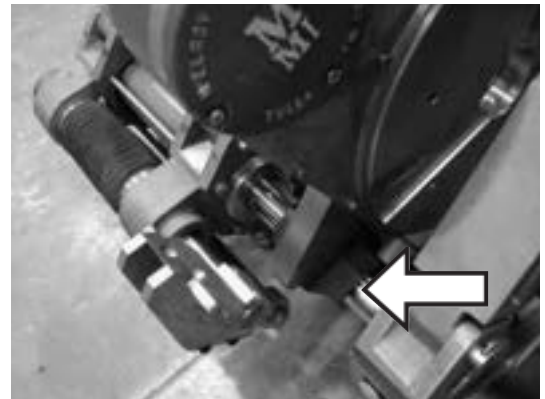

PH01946-11-15-00

TX01887-11-15-00

Removing Top Jaws

If the carriage is going to be hand carried, or if the carriage needs to be hoisted and slid underneath the pipe, the top jaws need to be removed.

Loosen all clamp knobs. Take out the detent pins securing the top jaws and remove the jaws.

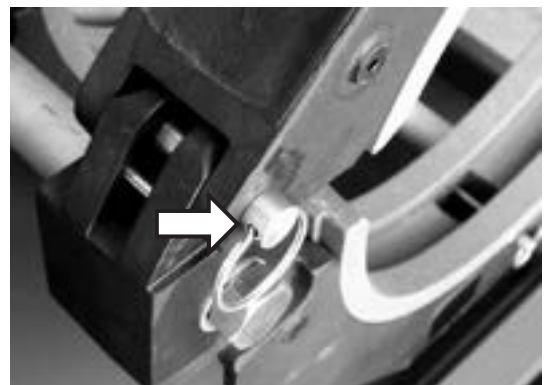

PH01305-3-12-98

TX01479-2-26-98



Lower 3-Jaw or 4-Jaw Carriage into Ditch

Use all 4 jaws whenever possible. The three jaw unit should be used only when space is not available for the entire carriage, such as fusing onto a tee, an ell or doing saddle fusion

4-Jaw

Attach lifting sling to the manifold bracket and the near side lift point.

Lift carriage assembly and lower into ditch.

3-Jaw

Attach lifting sling to the manifold bracket.

Lift carriage assembly and lower into ditch.



PH01983-11-15-00

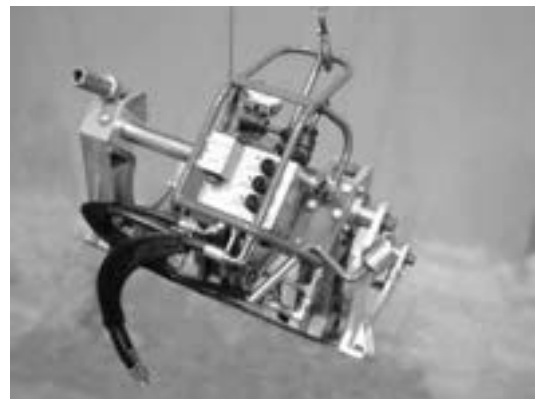

PH01984-11-15-00



Clamp Carriage Assembly To Pipe

Position carriage assembly on side of the pipe. Lift pipe and slide carriage assembly under pipe.

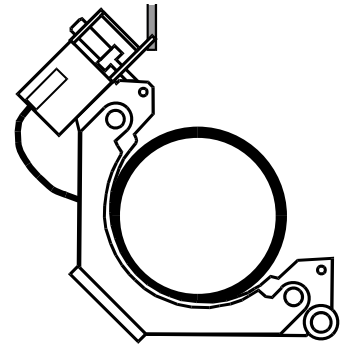

CD00193B-2.19-96

Rotate carriage assembly around to a normal upright position.

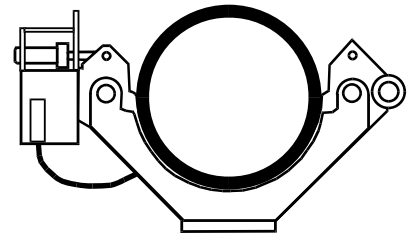

CD00194B-2.19-96

Attach the top jaws and clamp around pipe.

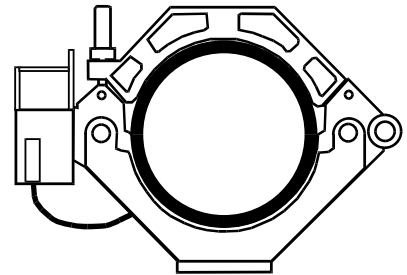

CD00195A-2.19-96

TX00879-2.19-96



Special Operations - In-Ditch



Lower Facer Into Ditch

Attach lifting sling to the large upper handle on facer and lower into position and reattach.

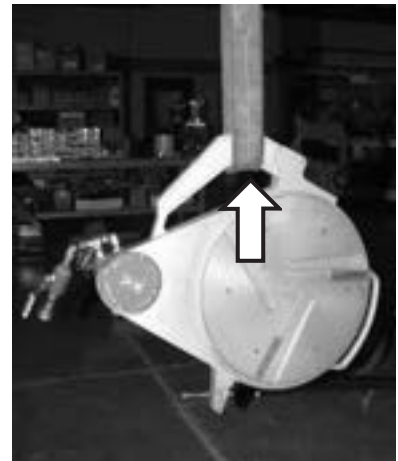

PH0258409-18-03

TX02222-09-18-03

Make Fusion Joint

Refer to the "Butt Fusion Procedure" for operating instructions.
After facing operation, remove the facer from ditch.

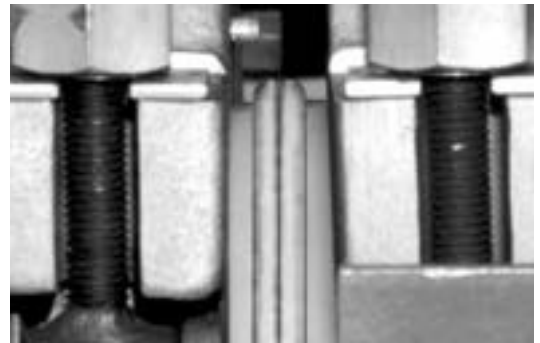

PH00363B-9-12-94

TX00450-9-16-94

Remove Carriage Assembly From Ditch

Loosen clamp knobs and remove top jaws.

Rotate carriage assembly from under the pipe.

IMPORTANT Always rotate unit with valve system facing up to protect against damage.

Attach sling to lifting point.

Lift carriage assembly from ditch.

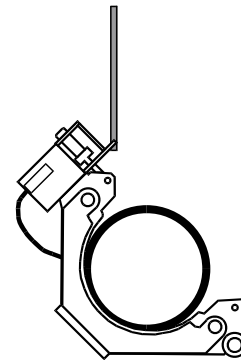

CD00193B-2-19-96

TX00451-9-16-94

Reassemble Fusion Machine

Bolt carriage assembly to the chassis and replace standard hoses.

Lift facer and place it in position.

Bring carriage against the facer to insure proper alignment and tighten the facer locking bolt.

Replace facer hoses.

Replace top jaws.



PH02582-09-18-03

TX00452-9-16-94



Lifting Fusion Machine



Heavy Overhead Load



Pipe stand and plastic pipe are heavy. If loaded or lifted improperly, they could crush or kill. Handle load carefully with proper overhead rigging and equipment of adequate load rating.

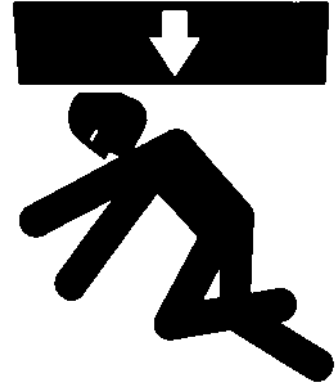

TX00062-3-8-93

WR00014-3-8-93

Crush Points



Crush points exist on this machine. Scissor action of this machine could crush or sever body parts. Keep hands and body parts away from the stand. Be aware of yourself and others when adjusting or moving stand.

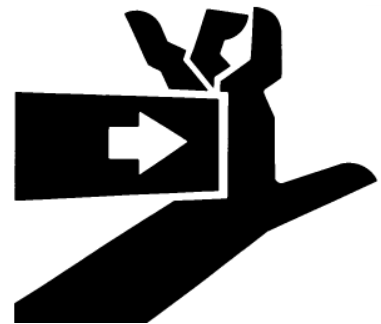

TX00060-3-10-93

WR00012-12-4-92

Lifting Sling

A special lifting sling is shipped with each machine. There are two lifting eyes on each side of the chassis frame. Attach all four hooks on the lifting sling to the lifting eyes.

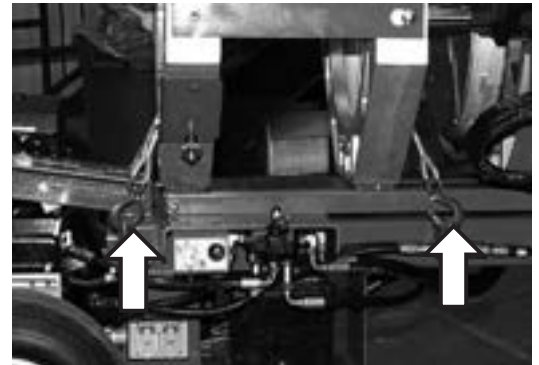

TX01264-2-20-97

PH01102-2-20-97

Lifting Safety

Follow all applicable federal, state, local, and industry specific regulations when lifting unit.

Never carry loads over people.



TX00410-10-12-93

SAFE1st12-14-92



Lifting Fusion Machine



Lift Equipment

Using proper overhead rigging and equipment of adequate load rating, lift the fusion unit.

See the Specification Section for the weights of your fusion machine.



PH02601-09-18-03

TX00900-3-25-96



Maintenance



Preventative Maintenance

To insure optimum performance, the machine must be kept clean and well maintained.

With reasonable care, this machine will give years of service. Therefore, it is important that a regular schedule of preventive maintenance be kept.

Store machine inside, out of the weather, whenever possible.

TX00428-8-10-95

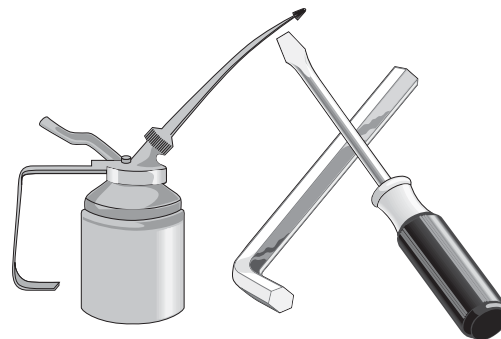

CD00142-11-2-94

Washing the Machine

The machine should be cleaned, as needed with a soap and water wash.

TX00429-9-15-94



CD00178-9-15-95

Check Hydraulic Fluid

The hydraulic fluid level should be checked daily.

If hydraulic oil is not visible in the sight gauge, oil must be added.

Refer to the "Hydraulic Fluids" section of this manual for hydraulic oil recommendations.

TX00430-9-22-94



PH02602-09-18-03

Change Hydraulic Fluid and Filter

The hydraulic fluid and filter should be replaced when the filter pressure gauge indicates "service filter".

Fluid should also be changed as extreme weather conditions dictate.

Refer to the "Hydraulic Fluids" section of this manual for hydraulic oil recommendations.

TX02140-07-11-03



PH02603-09-18-03



Maintenance



Check Gauge

Gauge should be checked daily.
The gauge should read zero when the unit is not running.
Damaged gauges should be replaced.

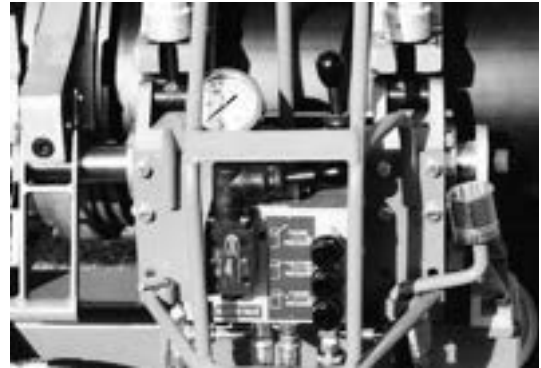

PH01030-2-20-97

TX02291-3-8-04

Clean Jaws and Inserts

To prevent slippage and insure proper alignment, the jaws and inserts must be clean.
Clean the jaws and inserts of any dirt or residual material using a stiff-bristled brush.



PH02687-3-8-04

TX00433-9-15-94

Clean Thrust Bearings

The thrust bearings located in the clamp knobs must turn freely.
Wash the clamp knob bearing assembly with a solvent, and then lubricate with 30W or lighter oil.

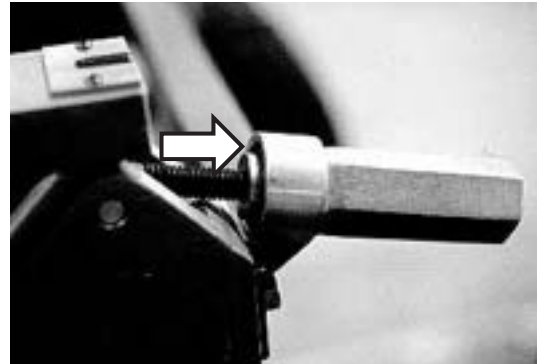

PH00732-3-1-96

TX00434-9-13-94

Clean Eyebolt Threads

Keep the clamp knob eyebolt threads brushed clean.

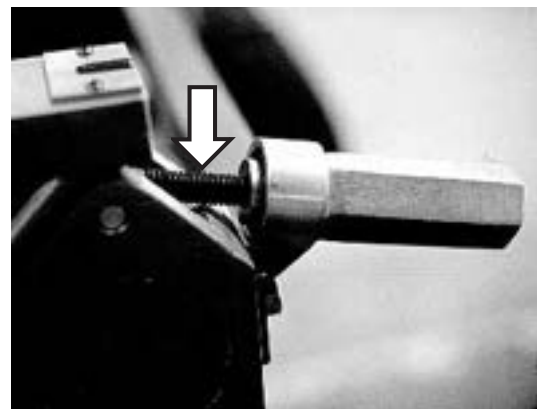

PH00732-3-1-96

TX00435-9-13-94



Bleeding Air From Hydraulic System

The two carriage cylinders have air bleed **screws** and must be bled if the system ever runs low on oil or leaks air on inlet side of pump. Air in the system is indicated when carriage movement becomes jerky and erratic. To bleed the system, proceed as follows:

Tilt machine so the fixed jaw end is higher than the opposite end. Shift the directional control and move the carriage to the fixed jaw end. Adjust the pressure to approximately 50-100 psi before proceeding.

Loosen the bleed plug on one cylinder next to the fixed jaw.

Hold pressure on the cylinder until no air is indicated and quickly tighten the plug.

Repeat this operation on the opposite cylinder.

Tilt the machine so the opposite end is higher than the fixed jaw end. Move the carriage to the end opposite the fixed jaw and repeat the above procedure on the this end of the cylinders.

TX00877-2-16-96

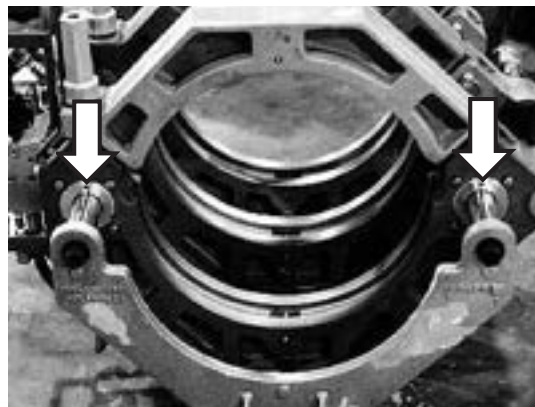

PH00720-2-16-96

Facer Blades

Blades bolt directly to the blade holder and should be inspected for damage and sharpness.

Dull or chipped blades must be replaced.

NOTICE: Never extend the blade beyond the inner or outer circumference of the facer.

TX02475-3-29-05



PH02576-09-18-03

Clean Heater Surfaces

The heater faces must be kept clean and free of any plastic build up or contamination.

Before each fusion joint the heater surfaces must be wiped with a clean, non-synthetic cloth.

NOTICE: Do not use an abrasive pad or steel wool. Use a non-synthetic cloth that won't damage surfaces.

TX00440-8-14-08



PH02333-6-28-02



Maintenance



Installing Butt Fusion Heater Plates

Coated butt fusion heater plates are available for all non-coated heaters.

Butt fusion heater plates are installed with eight Stainless Steel Cap Screws.

Care should be taken to assure that the butt fusion heater plates are seated on the heater body, and that there is no foreign matter trapped between these surfaces.

IMPORTANT: Do not over tighten the bolts.

The surface of the butt fusion heaters are coated with an antistick coating.

TX01092-8-20-96



PH02332-6-28-02

Adjusting Heater Temperature

Turn knob to desired temperature. Measure the heater surface temperature with a pyrometer. Any variance must be corrected to the pyrometer reading.

Loosen setscrew in the knob. Turn knob to point to the same temperature as the pyrometer. Tighten setscrew in the knob.

Turn knob to desired temperature. Allow heater to stabilize at the new temperature (5 to 10 minutes) after adjusting.

The thermometer on the heater body indicates internal temperature and should be used as a reference only.

TX02030-6-28-02



PH02313-6-28-02

Heater Indicator Light

The heater has a green indicator light which will flash on and off. This indicates that the controller is operating normally. If the green indicator is not flashing then the controller may not be operating properly. If this occurs, disconnect power and have the heater repaired by an McElroy Authorized Service Center.

The heater has a red indicator light on the handle at the bottom of the temperature scale. When the heater is plugged in and preheating the light glows steadily until the set temperature is reached. The light then goes off and on slowly as the heater maintains temperature.

If the heater is not operating properly, the control will attempt to turn the heater off and the indicator light will flash rapidly. If this occurs, disconnect the power and take it to a McElroy Authorized Service Center for repair.

TX02213-09-16-03



PH02314-6-28-02

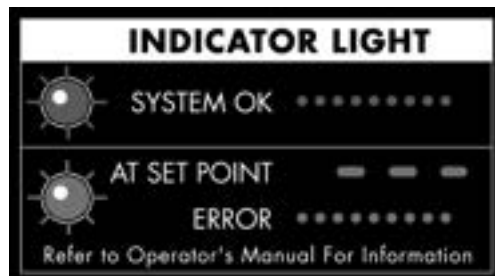

PH02571-09-16-03



Fasteners Must Be Tight

Check all nuts, bolts, and snap rings to make certain they are secure and in place.



PH00731-2-22-96



PH02583-09-18-03

TX00437-9-13-94



Maintenance Checklist



Fusion Machine Checklist

Item to Check	Satisfactory	Needs Repair	Repair Comments
Machine is clean			
All pins and snaprings are in place			
All nuts and bolts are tight			
All placards and handles are in place			
All clamp knobs turn freely			
Cords and plugs are in good condition			
All hardware is on the basic machine			
Oil reservoir is filled to correct level			
Machine is free of hydraulic leaks			
Hydraulic gauge reads correctly			
Brake functions properly			
Tire pressure is correct			
Jaws are properly aligned			
Facer pivot operates properly			
Facer operates smoothly			
Face-off is square			
Inserts fit and pin properly			
Primary pump pressure can be adjusted from 500 psi to 1000 psi			
Voltage to electrical models and heaters is 240V			
Carriage and Selector Valves operate smoothly			
Pressure Reducing Valves operate in their range			
Filter gauge reads correctly			
HEATER			
Heater surface is clean and in good condition			
Heater surface is clean and in good condition			
Thermometer is in good working order			
Surface temperature checked with pyrometer			
Check receptacles for damage			



Determining Fusion Pressure



Variable Definitions

- O.D. = Outside Diameter
- t = Wall Thickness
- Π = 3.1416
- SDR = Standard Dimensional Ratio
- IFP = Manufacturer's Recommended Interfacial Pressure
- TEPA = Total Effective Piston Area

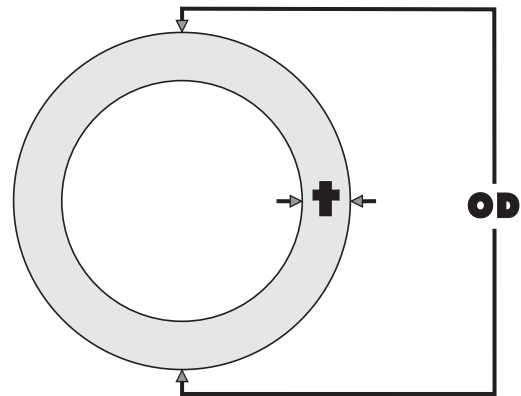

Formulas

$$t = \frac{\text{O.D.}}{\text{SDR}}$$

$$\text{AREA} = (\text{O.D.} - t) \times t \times \Pi$$

$$\text{FORCE} = \text{AREA} \times \text{IFP}$$

$$\text{GAUGE PRESSURE} = \frac{(\text{O.D.} - t) \times t \times \Pi \times \text{IFP}}{\text{TEPA}} + 30 \text{ P.S.I. DRAG}$$

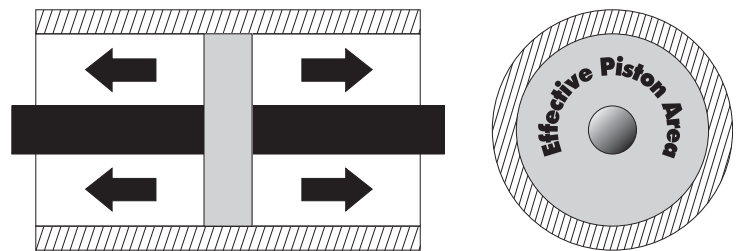

Example

- Pipe Size = 8" IPS
- O.D. of Pipe = 8.625
- SDR of Pipe = 11
- Recommended Interfacial Pressure = 75 PSI
- Using a Model 28 Fusion Unit

$$t = \frac{\text{O.D.}}{\text{SDR}} = \frac{8.625}{11} = 0.784$$

TEPA = 4.710 (From Table)

$$\text{GAUGE PRESSURE} = \frac{(\text{O.D.} - t) \times t \times \Pi \times \text{IFP}}{\text{TEPA}} + 30 \text{ P.S.I. DRAG}$$

$$\text{GAUGE PRESSURE} = \frac{(8.625 - .784) \times .784 \times 3.1416 \times 75}{4.710} + 30 \text{ P.S.I. DRAG} = 338 \text{ PSI}$$

Total Effective Piston Areas

Fusion Model	High Force (Standard)	Medium Force (High Velocity)	Low Force (Extra High Velocity)
28	4.71	-	1.67
412	11.78	6.01	3.14
618	11.78	6.01	3.14
824	29.44	15.32	9.45
1236	29.44	15.32	9.45
1648	31.42	14.14	-
2065	31.42	-	-



Hydraulic Fluids



Hydraulic Fluids

The use of proper hydraulic oil is mandatory to achieve maximum performance and machine life. Use a clean, high quality, anti-wear hydraulic oil with a viscosity index (VI) of 135 minimum. It should have a maximum viscosity of 500 cSt (2000 SSU) at startup (ambient temperature) and a minimum viscosity of 13 cSt (65 SSU) at the maximum oil temperature (generally 80°F above ambient). Using hydraulic oils that do not meet these criteria may cause poor operation and/or damage to the hydraulic components.

The following table specifies the oil temperature at various viscosities. Temperature rise of the hydraulic oil can vary from 30° F to about 80° F over the ambient temperature depending on the pressure setting, age of the pump, wind, etc. Exxon Univis N46 hydraulic oil is installed at our factory. The advantage of this oil is a wider temperature range, however, this oil should not be used for continuous operation below 20° F. For use in extremely cold ambient temperatures, we suggest Mobil DTE 11M, which can be used to -16° F. This oil should not be used for continuous operation above 100° F (oil temperature).

TX02244-2-2-04

Hydraulic Fluids Characteristics																
Manufacturer	Fluid Name	SSU 100F	SSU 210F	V.I.	-20F	-10F	0F	10F	30F	50F	70F	90F	110F	130F	150F	Range °F
Mobil	DTE 11M	87	40	145	*	*	*	*	*	*	*	*	*	*	*	-27-87
	DTE 13M	165	48	140				*	*	*	*	*	*	*	*	5-130
	DTE 15M	225	53	140				*	*	*	*	*	*	*	*	5-140
Exxon	Univis N-32	177	49	164				*	*	*	*	*	*	*	*	5-140
	Univis N-46	233	55	163					*	*	*	*	*	*	*	25-142
	Univis N-68	376	68	160						*	*	*	*	*	*	34-155

NOTE: This chart is based on pump manufacturer recommendations of 65 to 2000 SSU limits.

NOTE: Temperatures shown are fluid temperatures. – NOT ambient temperatures.



Specifications



Model 412

Dimensions

Width: 49" (124.5 cm)
 Length: 85" (215.9 cm)
 Height: 46" (116.8 cm)

Weight

No.412: 1225 lbs (555.7 Kg)
 No.412E: 915 lbs (415 Kg)
 Facer: 57 lbs (25.6 Kg)
 Heater: 22 lbs (10.0 Kg)
 3000 W, 240 V, single phase
 AC only, 60 Hz (50 Hz)
 Top Works: 343 lbs. (155.6 Kg)

Electric Model 412E

Minimum Power Requirement: 5.5 kW/6.5 kVA
 3 Phase, 240 V, 60 Hz (50 Hz)

Hydraulics

Reservoir Capacity: 5 Gallons
 Hydraulic Fluid: Sunvis 2105 or equivalent hydraulic oil
 Tire Pressure: 70 psi

Model 618

Dimensions

Width: 50" (127 cm)
 Length: 85" (215.9 cm)
 Height: 55" (139.7 cm)

Weight

No.618: 1335 lbs (605.6 Kg)
 No.618E: 1100 lbs (498.3 Kg)
 Facer: 89 lbs (40 Kg)
 Heater: 6-12" Assembly 20 lbs. (9.1 Kg)
 12-18" Assembly 29 lbs. (13.2 Kg)
 3000 W, 240 V, single phase
 AC only, 60 Hz (50 Hz)
 Top Works: 441 lbs. (200 Kg)

Electric Model 618E

Minimum Power Requirement: 7.5 kW/6.5 kVA
 3 Phase, 240 V, 60 Hz (50 Hz)

Hydraulics

Reservoir Capacity: 5 gallons
 Hydraulic Fluid: Sunvis 2105 or equivalent hydraulic oil
 Tire Pressure: 70 psi



Specifications



Generator Sizing Form

Complete this form and provide a copy to your generator supplier. This information will enable your generator supplier to correctly size a generator for your application.

Motor: _____ 3.0 Horsepower for Model 412E
5.0 Horsepower for Model 618E

Motor Code Letter: H (from motor nameplate)

Motor Voltage: 240 VAC

Motor Phases: 3 Delta

Motor Frequency: _____ (50 or 60 Hz)

Heater Wattage Rating: 3000 Watts resistive

Heater Voltage: 240 VAC

Operational Altitude Range: _____ to _____

Ambient Temperature Range: _____ to _____

Duty Cycle: Standby (Not continuous 24 hours/day)

Allowable Voltage Dip: 20%

Allowable Frequency Dip: 5%

Starting Load Application: Simultaneous turn-on of both motor and heater.

Running Load: Motor continuous, heater cycling on and off at approximately 5 minute intervals.

Fuel: _____ (Gasoline or Diesel)

Special requirements for customer application: _____

About this manual . . .

McElroy Manufacturing continually strives to give customers the best quality products available. This manual is printed with materials made for durable applications and harsh environments.

This manual is waterproof, tear resistant, grease resistant, abrasion resistant and the bonding quality of the printing ensures a readable, durable product.

The material does not contain any cellulose based materials and does not contribute to the harvesting of our forests, or ozone-depleting constituents. This manual can be safely disposed of in a landfill and will not leach into ground water.

TX001660-8-19-99



The leader by design.

P.O. Box 580550 Tulsa, Oklahoma 74158-0550, USA
www.mcelroy.com